



***5th WORLD
JUNIOR CANOE
CHAMPIONSHIPS***



RAČICE

29. 7. - 1. 8. 1993

CZECH REPUBLIC





International
Canoe Federation

5th WORLD JUNIOR
CANOE
CHAMPIONSHIPS



29.7. - 1.8. 1993
RAČICE
CZECH REPUBLIC



Czech Canoe
Union

JURY

<i>President</i>	Sergio ORSI	ITA
	Otto BONN	HUN
	Ulrich FELDHOFF	GER
	Etsuya HOSOTANI	JPN
	Miroslav HYPŠ	CZE
	Jose PERURENA	ESP
	Andre VANDEPUT	BEL

ICF ROZHODČÍ - ICF OFFICIALS

<i>Hlavní rozhodčí - Chief Official</i>	John LEUKEMANS	BEL
---	----------------	-----

<i>Technický komisař - Technical Organiser</i>	Blanka BAĐUROVÁ	CZE
--	-----------------	-----

<i>Cíloví rozhodčí - Finishing Lines Judges</i>	Gunter BYHAN	GER
	Jose FERREIRA	POR
	Fernando VAZQUEZ	ESP
	Spyros FILIPPOUSIS	GRE
	Mykolas RUDINKAS	LTU
	Jozsef TARCSAFALVI	HUN

<i>Startéři - Starters</i>	Otto TOMIUC	ROM
	Mike MOIR	CAN

<i>Startéři na 25 m - Starter/25m Umpires</i>	Rosemary GREY	GBR
	E.A. STORMIK	NED

<i>Rozhodčí na trati - Course Umpires Judges</i>	Dan AMPER	ISR
	Corneliu BARSANESCU	ROM
	Peter BLAND	GBR
	Zoltan HORVATH	HUN
	Etiene JANSSENS	BEL
	Marek VISLA	POL

<i>Předstartéři - Aligners</i>	Miroslav HAVIAR (pomocní startéři)	SVK
	Václav ADAMEC	CZE

<i>Kontrola lodí - Boats Control</i>	Klaus HAUSMANN	GER
	Jesus R. INCLAN	ESP
	Luboš KUNC	SVK
	Kazimier WOLNY	POL





International
Canoe Federation

5th WORLD JUNIOR
CANOE
CHAMPIONSHIPS



29.7. - 1.8. 1993
RAČICE
CZECH REPUBLIC



Czech Canoe
Union

Pořadatel - Promoter

Mezinárodní kanoistická federace
International Canoe Federation

Organisátor - Organiser

Český svaz kanoistů
Czech Canoe Federation

Organisační výbor - Committee Organizer

Předseda - Chairman
Ladislav SOUČEK

Sekretář - Secretary
Jan BOHÁČ

Organisační vedoucí - Organisation Manager
Michal JEŽEK

Technický ředitel - Technical Director
Jaroslav BAĐURA

Ekonomický vedoucí - Chief of Economic
Jindřich LANGER

Vedoucí tiskového střediska - Chief of Presscentre
Eva KUTOVÁ

Vedoucí zdravotní služby - Chief of Medical service
Josef MARTINČA

Vedoucí dopravy - Chief of Transport
Jiří BOUŠÍ

Technická komise - Technical Committee
Luděk ONDRAČKA

Vyhlašování vítězů - Victory Ceremony
Pavel CHARVÁT

Vedoucí ubytování - Chief of Accomodation
Pavel VEJNAR



© Complete Office Equipment



SPONSORS

SAN TEAM	- health amenities - constructions and equipment
BOOTSBAU BERLIN GmbH	- construction of race boats
HBH	- minibrewery
C.O.E.	- copy technology
PVT PRAHA	- supplier of computer technology
2N	- supplier of telecommunication technology
RMC Radiokomunikace	- transmitters, radiotelephones
GWC	- Golden World Club
MODŘANSKÁ POTRUBÍ a.s.	- engineering amenities
HORNICKÁ ZAMĚSTNANECKÁ ZDRAVOTNÍ POJIŠŤOVNA	
TTC Tesla	- communication technology
MUZO Card	- plastic identification cards
TATRA Kopřivnice	- personal cars
PLŠKO SPORT	
JITEX Písek	- sports clothings
DIPLOMAT HOTEL Praha	
TECHNIASPORT Úst n. L.	- means of masage, equipment of sportplaces
AT & T - NSI Praha	- communication technology
AT & T - BCS Praha	- communication technology
ZÁCHRANNÁ SLUŽBA ASSOCIACE SAMARITÁNU ČR, Praha západ	- ambulance
SEPAP Štětí	- production of paper
LANIER	- copy technology

DIRECTION OF THE WIND IN RELATION TO THE COURSE

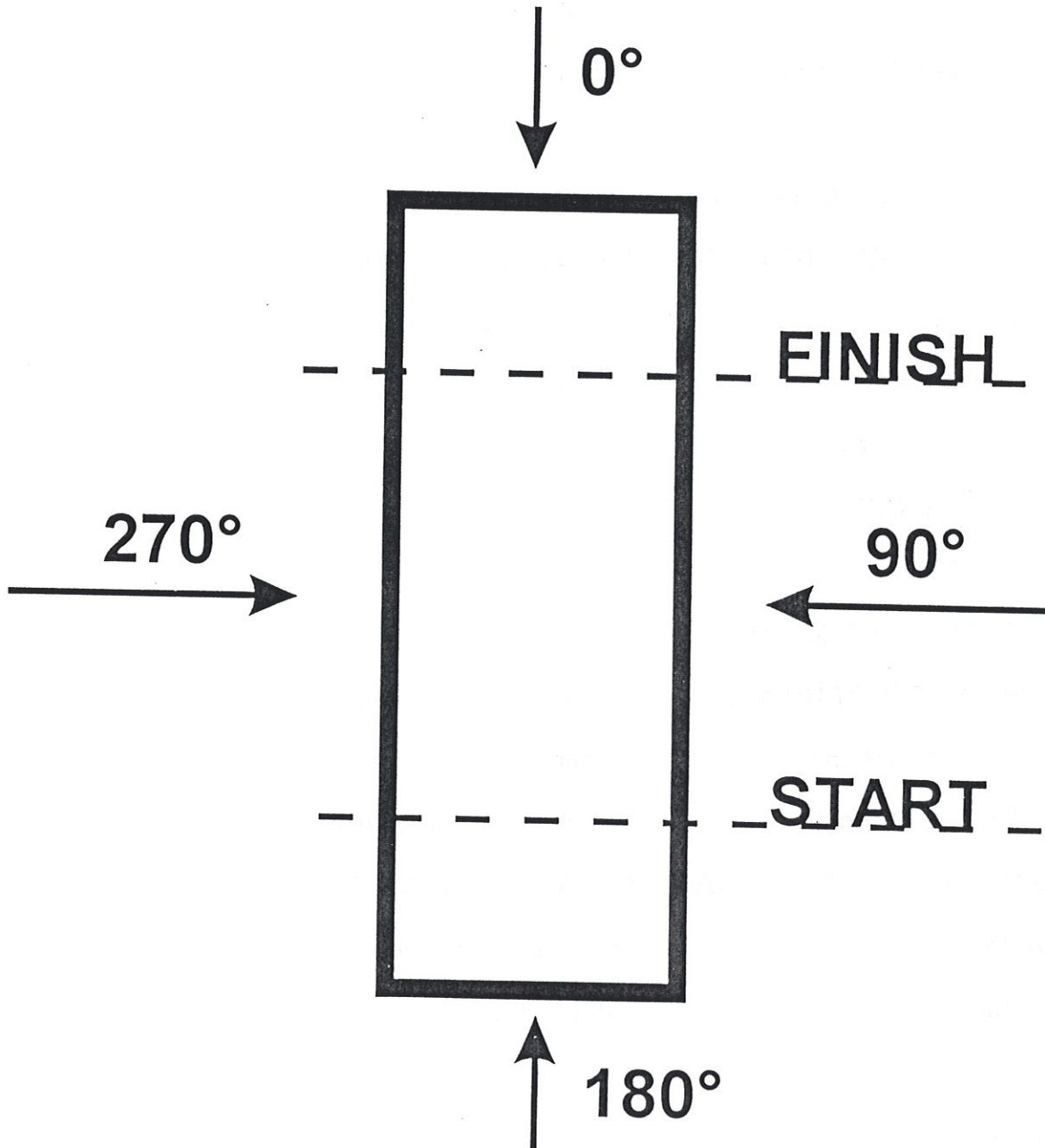

Casový rozvrh/Competition time-table

Ctvrtek/Thursday 29.7.1993
první den/first day

Rozjízdky - dopoledne
Heats - morning

1.	K1	500 m	Men	I	8:30
2.	K1	500 m	Men	II	8:40
3.	K1	500 m	Men	III	8:50
4.	K1	500 m	Men	IV	9:00
6.	C1	500 m	Men	I	9:20
7.	C1	500 m	Men	II	9:30
8.	C1	500 m	Men	III	9:40
9.	C1	500 m	Men	IV	9:50
10.	K1	500 m	Women	I	10:00
11.	K1	500 m	Women	II	10:10
12.	K1	500 m	Women	III	10:20
13.	K1	500 m	Women	IV	10:30
14.	K2	500 m	Men	I	10:40
15.	K2	500 m	Men	II	10:50
16.	K2	500 m	Men	III	11:00
17.	K2	500 m	Men	IV	11:20
18.	K2	500 m	Men	V	11:30
19.	C2	500 m	Men	I	11:40
20.	C2	500 m	Men	II	11:50
21.	C2	500 m	Men	III	12:00
22.	K2	500 m	Women	I	12:10
23.	K2	500 m	Women	II	12:20
24.	K2	500 m	Women	III	12:30
25.	K4	500 m	Men	I	12:40
26.	K4	500 m	Men	II	12:50
27.	K4	500 m	Men	III	13:00
28.	K4	500 m	Men	IV	13:10
29.	C4	500 m	Men	I	13:20
30.	C4	500 m	Men	II	13:30

Opravné jízdy - odpoledne
Repechages - afternoon

31.	K1	500 m	Men	I	16:00
32.	K1	500 m	Men	II	16:10
33.	K1	500 m	Men	III	16:20
34.	C1	500 m	Men	I	16:30
35.	C1	500 m	Men	II	16:40
36.	C1	500 m	Men	III	16:50
37.	K1	500 m	Women	I	17:00
38.	K1	500 m	Women	II	17:10
39.	K1	500 m	Women	III	17:20
40.	K2	500 m	Men	I	17:30
41.	K2	500 m	Men	II	17:40
42.	K2	500 m	Men	III	17:50
43.	C2	500 m	Men	I	18:00
44.	C2	500 m	Men	II	18:10
45.	K2	500 m	Women	I	18:20
46.	K2	500 m	Women	II	18:30
47.	K4	500 m	Men	I	18:40
48.	K4	500 m	Men	II	18:50
49.	K4	500 m	Men	III	19:00



International
Canoe Federation

5th WORLD JUNIOR
CANOE
CHAMPIONSHIPS



29.7. - 1.8. 1993
RAČICE
CZECH REPUBLIC



Czech Canoe
Union

Casový rozvrh/Competition time-table

Patek/Friday 30.7.1993
druhý den/second day

Rozjízdky - dopoledne
Heats - morning

50.	K1	1000 m	Men	I	8:30
51.	K1	1000 m	Men	II	8:40
52.	K1	1000 m	Men	III	8:50
53.	K1	1000 m	Men	IV	9:00
54.	C1	1000 m	Men	I	9:10
55.	C1	1000 m	Men	II	9:20
56.	C1	1000 m	Men	III	9:30
58.	K4	500 m	Women	I	9:50
59.	K4	500 m	Women	II	10:00
60.	K4	500 m	Women	III	10:10
61.	K2	1000 m	Men	I	10:20
62.	K2	1000 m	Men	II	10:30
63.	K2	1000 m	Men	III	10:40
64.	K2	1000 m	Men	IV	10:50
66.	C2	1000 m	Men	I	11:10
67.	C2	1000 m	Men	II	11:20
68.	C2	1000 m	Men	III	11:30
69.	K4	1000 m	Men	I	11:40
70.	K4	1000 m	Men	II	11:50
71.	K4	1000 m	Men	III	12:00
72.	K4	1000 m	Men	IV	12:10
73.	C4	1000 m	Men	I	12:20
74.	C4	1000 m	Men	II	12:30

Opravné jízdy - odpoledne
Repechages - afternoon

75.	K1	1000 m	Men	I	16:00
76.	K1	1000 m	Men	II	16:10
77.	K1	1000 m	Men	III	16:20
78.	C1	1000 m	Men	I	16:30
79.	C1	1000 m	Men	II	16:40
81.	K4	500 m	Women	I	17:00
82.	K4	500 m	Women	II	17:10
83.	K2	1000 m	Men	I	17:20
84.	K2	1000 m	Men	II	17:30
85.	K2	1000 m	Men	III	17:40
86.	C2	1000 m	Men	I	17:50
87.	C2	1000 m	Men	II	18:00
88.	K4	1000 m	Men	I	18:10
89.	K4	1000 m	Men	II	18:20
90.	K4	1000 m	Men	III	18:30



© Complete Office Equipment





International
Canoe Federation

5th WORLD JUNIOR
CANOE
CHAMPIONSHIPS



29.7. - 1.8. 1993
RACICE
CZECH REPUBLIC



Casový rozvrh/Competition time-table

Sobota/Saturday 31.7.1993
tretí den/third day

Mezijízdy - dopoledne	91.	K1	500 m	Men	I	8:30
Semi-finals - morning	92.	K1	500 m	Men	II	8:40
	94.	C1	500 m	Men	I	9:00
	95.	C1	500 m	Men	II	9:10
	96.	K1	500 m	Women	I	9:20
	97.	K1	500 m	Women	II	9:30
	98.	K2	500 m	Men	I	9:40
	99.	K2	500 m	Men	II	9:50
	100.	K2	500 m	Men	III	10:00
	101.	C2	500 m	Men	I	10:10
	102.	C2	500 m	Men	II	10:20
	103.	K2	500 m	Women	I	10:30
	104.	K2	500 m	Women	II	10:40
	105.	K4	500 m	Men	I	10:50
	106.	K4	500 m	Men	II	11:00
	107.	C4	500 m	Men	I	11:10
	108.	C4	500 m	Meň	II	11:20
Finále - odpoledne	109.	K1	500 m	Men		15:30
Finals - afternoon	110.	C1	500 m	Men		15:50
	111.	K1	500 m	Women		16:10
	112.	K2	500 m	Men		16:30
	113.	C2	500 m	Men		16:50
	114.	K2	500 m	Women		17:10
	115.	K4	500 m	Men		17:30
	116.	C4	500 m	Men		17:50

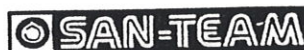



International
Canoe Federation

5th WORLD JUNIOR
CANOE
CHAMPIONSHIPS



29.7. - 1.8. 1993
RACICE
CZECH REPUBLIC



Czech Canoe
Union

Casový rozvrh/Competition time-table

Nedele/Sunday 1.8.1993
ctvrty den/fourth day

Mezijízdy - dopoledne	117.	K1	1000 m	Men	I	9:00
Semi-finals - morning	118.	K1	1000 m	Men	II	9:10
	119.	C1	1000 m	Men	I	9:20
	120.	C1	1000 m	Men	II	9:30
	121.	K4	500 m	Women	I	9:40
	122.	K4	500 m	Women	II	9:50
	123.	K2	1000 m	Men	I	10:00
	124.	K2	1000 m	Men	II	10:10
	126.	C2	1000 m	Men	I	10:30
	127.	C2	1000 m	Men	II	10:40
	128.	K4	1000 m	Men	I	10:50
	129.	K4	1000 m	Men	II	11:00
	130.	C4	1000 m	Men	I	11:10
	131.	C4	1000 m	Men	II	11:20
Finále - odpoledne	132.	K1	1000 m	Men		15:30
Finals - afternoon	133.	C1	1000 m	Men		16:00
	134.	K4	500 m	Women		16:30
	135.	K2	1000 m	Men		17:00
	136.	C2	1000 m	Men		17:30
	137.	K4	1000 m	Men		18:00
	138.	C4	1000 m	Men		18:30





International
Canoe Federation

5th WORLD JUNIOR
CANOE
CHAMPIONSHIPS



29.7. - 1.8. 1993
RAČICE
CZECH REPUBLIC



STARTOVNÍ LISTINA / START LIST

LIST OF COMPETITORS

BUL - Bulgaria

81	Zamfirova Nely
82	Angelov Atanas
83	Atanasov Dimitar
84	Atanasov Stanimir
85	Karadjov Petar
86	Merkov Petar
87	Nikolov Georgi
88	Nikolov Rumén
89	Petrov Genaedi
90	Spasov Trendafil

CAN - Canada

101	Furneaux Karen
102	Giles Kristina
103	Mckenzie Laura
104	O'Neil Barbara
105	Prince Karina
106	Brine Cameron
107	Buday Tamas
108	Cobb Graham
109	Illsley Scott
110	Larose Maxime
111	Lovatt Paul
112	Maksymiuk Daniel
113	Phelan Richard
114	Richardson Adrian
115	Scarola Mike
116	Smith Dave
117	Zacharuk Kyle

CRO - Croatia

121	Kriskovic Ervina
122	Ribaric Marina
123	Funtak Drazen

CZE - Czech Republic

131	Borkovcova Sarka
132	Folbrechtova Eva
133	Hekova Katerina
134	Hlucha Katerina
135	Nikodymova Zuzana
136	Pergnerova Milena
137	Brecka Jan
138	Bulinsky Robert
139	Dolezal Petr
140	Dvorak Martin
141	Hejda Premysl
142	Juttner Tomas
143	Kadlec Filip
144	Kolanda Jan
145	Kolisek Petr
146	Kosik Jan
147	Kozelsky David
148	Machac Jan
149	Marisko Jan
150	Mraz Pavel
151	Pojezny Petr
152	Prchal Martin
153	Sarka Jan
154	Sebesta Jiri
155	Stejskal Jan
156	Sterba Petr
157	Termer Vlastimil
158	Tonder Tomas
159	Vanicek Vit

DEN - Denmark

171	Andersen Brian
172	Eilert Michael
173	Grau Christian
174	Heering Nicolai
175	Korshin Andre
176	Olsen Rene
177	Rasmussen Brian
178	Scales Carsten
179	Svenningen Claus



COMPUTER SYSTEMS





International
Canoe Federation

5th WORLD JUNIOR
CANOE
CHAMPIONSHIPS



29.7. - 1.8. 1993
RAČICE
CZECH REPUBLIC



Czech Canoe
Union

STARTOVNÍ LISTINA / START LIST

LIST OF COMPETITORS

ARG - Argentina

- 1 Donadio Valeria
- 2 Maino Andrea
- 3 Basualto Ariel
- 4 Canepa Diego
- 5 Correa Javier
- 6 Linares Javier
- 7 Suaya Pablo
- 8 Virkel Sebastian

BEL - Belgium

- 41 Bernaerts Peter
- 42 Deslee Henk
- 43 Maesen Bob
- 44 Noppe Tom
- 45 Plomteux Laurens
- 46 Ponnet Wim
- 47 Stevens David
- 48 Vandенbruwaene Leslie

AUS - Australia

- 11 Marot Christy
- 12 Nossiter Yanda
- 13 Baggaley Nathan
- 14 Beresford-Peirse Digby
- 15 Chalmers Luke
- 16 Chilvers Mike
- 17 Clayton James
- 18 Croker Glen
- 19 Curry Billy
- 20 Evans Peter
- 21 Ingerman Matthew
- 22 Prosser Greg

BLR - Belarus

- 51 Bet Elena
- 52 Maslova Natalia
- 53 Pajgraj Nadezhda
- 54 Subotenko Olga
- 55 Vzdulskaja Natalia
- 56 Borisik Piotr
- 57 Degtiariov Vladislav
- 58 Gintoft Mikhail
- 59 Kalesnik Dmitrij
- 60 Kirilenko Victor
- 61 Koncevoj Oleg
- 62 Markosian Mikhail
- 63 Povalanskij Valerij
- 64 Rubanov Gennadij
- 65 Yourchyk Aleksandr
- 66 Zhookovskij Dmitrij
- 67 Zujev Aleksandr
- 68 Zujev Vitalij

AUT - Austria

- 31 Schlitzer Petra
- 32 Hinterhofer Martin
- 33 Stollnberger Markus

BRA - Brazil

- 71 Lopes Denis Ferre
- 72 Lozz Ricardo
- 73 Mattiello Bruno Lebr.



International
Canoe Federation

5th WORLD JUNIOR
CANOE
CHAMPIONSHIPS



29.7. - 1.8. 1993
RACICE
CZECH REPUBLIC



STARTOVNÍ LISTINA / START LIST

LIST OF COMPETITORS

ESP - Spain

191 Aramburu Izaskum
192 Fernandez Cristina
193 Iglesias Andrea
194 Manchon Beatriz
195 Romero Antonia
196 Alonso Verisimo
197 Busto Manuel
198 Cuinas Antonio
199 Fernandez Raimundo
200 Garcia Carlos
201 Gonzales Jovino
202 Leal Carlos
203 Mascato David
204 Merchan Emilio
205 Pena Basilio
206 Perez Gustavo
207 Villar Jesus

FRA - France

221 Agnes Isabelle
222 Bonnefoy Cecile
223 Clet Cecile
224 Gaultier Anne Sophie
225 Koenders Nathalie
226 Metenier Linda
227 Assa Martin
228 Barbey Laurent
229 Bocage Etienne
230 Ethuin David
231 Huguet Cyril
232 Lavigne Yannick
233 Moreaux Denis
234 Normand Samuel
235 Rebours Loic
236 Richard Alban
237 Robert Yann
238 Vossion Damien

EST - Estonia

211 Merila Age
212 Hollo Mihkel
213 Koiva Kaspar
214 Lelov Toomas
215 Rumm Ranno
216 Vello Raul

GBR - Great Britain

241 Campbell Beth
242 Fowler Suzanne
243 Giles Rebecca
244 Hardy Katie
245 Hemmings Anna
246 Ormerod Emily
247 Bull Martin
248 Crowther Stuart
249 Darby Dowman Paul
250 Enoch Matthew
251 Hemmings Brian
252 James Ian
253 Lane Malcolm
254 Love Jonathan
255 Pritchard Matthew
256 Sargeant Ian
257 Smith David
258 Tingay Stephen



COMPUTER SYSTEMS





International
Canoe Federation

5th WORLD JUNIOR
CANOE
CHAMPIONSHIPS



29.7. - 1.8. 1993
RACICE
CZECH REPUBLIC



Czech Canoe
Union

STARTOVNÍ LISTINA / START LIST

LIST OF COMPETITORS

GER - Germany

- 261 Bohm Michaela
- 262 Mucke Manuela
- 263 Muller Heike
- 264 Opgen-Rhein Nadine
- 265 Wagner Katrin
- 266 Bebber Ricardo
- 267 Gille Christian
- 268 Goedicke Robert
- 269 Heck Jens
- 270 Hesse Jan
- 271 Hornig Peter
- 272 Lehnert Sven
- 273 Mai Andre
- 274 Patzack Jens
- 275 Prange Christian
- 276 Ruhl Marco
- 277 Schmiech Daniel
- 278 Tiedge Rene
- 279 Ulm Stefan
- 280 Vesely Kay
- 281 Zeisner Daniel

GRE - Greece

- 291 Georgiadou Roza
- 292 Kukjias Kiki
- 293 Tsiupi Hrisula
- 294 Arapis Athanasios
- 295 Cogos Vangelis
- 296 Karakanakis Mihalis
- 297 Kiriazis Dimitrious
- 298 Marazopoulos Vasilis
- 299 Montanaris Stelios
- 300 Rountos Iorgos
- 301 Sideropoulos Panaiotis
- 302 Skoulariotis Georgos
- 303 Terzithis Teofanis
- 304 Vbranez Indra
- 305 Zachos Lukas

HUN - Hungary

- 311 Bankuti Judit
- 312 Barocsi Andrea
- 313 Horvath Reka
- 314 Kovacs Katalin
- 315 Luchterhand Larissza
- 316 Paulikovics Agnes
- 317 Acs Tamas
- 318 Almasi Peter
- 319 Balgovits Gabor
- 320 Bauer Marton
- 321 Buday Matyas
- 322 Csikos Gergely
- 323 Gajarszki Aron
- 324 Gyore Attila
- 325 Julis Attila
- 326 Kokeny Roland
- 327 Kovacs Akos
- 328 Kurucz Zoltan
- 329 Marsalla Viktor
- 330 Neuwirth Zsolt
- 331 Redenszki Antal
- 332 Storcz Akos
- 333 Storcz Botond
- 334 Szabo Roland
- 335 Telek Gabor
- 336 Varga Karoly

ISR - Israel

- 341 Carmi Lior
- 342 Hardoof Ronen





International
Canoe Federation

5th WORLD JUNIOR
CANOE
CHAMPIONSHIPS



29.7. - 1.8. 1993
RAČICE
CZECH REPUBLIC



STARTOVNÍ LISTINA / START LIST

LIST OF COMPETITORS

ITA - Italy

- 351 Pedrazzi Silvia
- 352 Pellegrini Ilenia
- 353 Ricciotti Anne Odette
- 354 Silvestri Sara
- 355 Ciacchella Ottavio
- 356 Bedin Andrea
- 357 Blasi Andrea
- 358 Bonacina Antonio
- 359 D'Amico Matteo
- 360 Frattini Luca
- 361 Majocchi Jacopo
- 362 Mangani Flavio
- 363 Mate Davide
- 364 Nardi Claudio
- 365 Pagni Alessandro
- 366 Favalli Simone
- 367 Ventriglia Alessandro
- 368 Nardelli Ciro

JPN - Japan

- 371 Junko Kono
- 372 Sanae Nakao
- 373 Sayuri Maruyama
- 374 Yoshika Oonishi
- 375 Eiji Uejyo
- 376 Hiroaki Matsumoto
- 377 Hiroyuki Sato
- 378 Kazunori Tagami
- 379 Kazutoshi Mishima
- 380 Kiyoshige Saito
- 381 Noritomo Shibuya
- 382 Riyuuki Shiraiwa
- 383 Shigeo Tanaka
- 384 Takaichi Nakatsu
- 385 Yasuo Miyake
- 386 Yoshimi Hosotani

KOR - Korea

- 391 Ji Mi Jun
- 392 Park Won Kyung
- 393 Kim Soon Suk
- 394 Kim Yong Kyo
- 395 Lee Kyung Soo
- 396 Lee Seoung Woo
- 397 Moon Chul Wook
- 398 Nam Sung Ho

LAT - Latvia

- 401 Cilinska Iveta
- 402 Ivanova Svetlana
- 403 Rituma Evija
- 404 Balabolins Kaspars
- 405 Berzins Kaspars
- 406 Buncis Edgars
- 407 Greizis Ugis
- 408 Klava Ainars
- 409 Kovalovs Sergejs
- 410 Lagzdins Valentins
- 411 Petersons Gundars
- 412 Zalupe Kristaps
- 413 Zvaigznons Ivaro



COMPUTER SYSTEMS



Complete Office Equipment



STARTOVNÍ LISTINA / START LIST

LIST OF COMPETITORS

LTU - Lithuania

- 421 Simonaviciute Vitalija
- 422 Balciunas Egidijus
- 423 Barysas Tomas
- 424 Gerulskis Edmundas
- 425 Gurskij Oleg
- 426 Jonkus Mindaugas
- 427 Medvedev Konstantin
- 428 Mironeko Ruslan
- 429 Paulauskas Dainius
- 430 Polomosnov Andrej
- 431 Varnas Tomas

NED - Nederland

- 471 v.d. Endt Marion
- 472 Ham Pauline
- 473 Leeman Minouk
- 474 Mantel Linda
- 475 de Rooy Maurits
- 476 Kossen Wouter
- 477 v.d. Pol Tobias
- 478 Visser Gido

MEX - Mexico

- 441 Valderrama Adriana
- 442 Castaneda Benjamin
- 443 Castaneda Jose Luis
- 444 Dominguez Emilio
- 445 Guerra Eduard
- 446 Heinze Ralph
- 447 Heredia Rafael
- 448 Revuelta Raul
- 449 Sierra Luis
- 450 Tovar Orion

NOR - Norway

- 481 Berntsen Anne Grete
- 482 Fjeloheim Marianne
- 483 Halano May Lise
- 484 Knuosen Christine
- 485 Tonnesen Renate
- 486 Fjeloheim Nils Olav
- 487 Gjeroe Andreas
- 488 Rudolfsen Frooe
- 489 Sigurosen Stian
- 490 Vigg Rowik

MLD - Moldava

- 461 Nenno Anna
- 462 Babitch Jeuri
- 463 Vitt Igori

STARTOVNÍ LISTINA / START LIST

LIST OF COMPETITORS

RUS - Russia

- 591 Anikeyeva Yuliya
- 592 Kononova Yuliya
- 593 Minayeva Marina
- 594 Starochenko Marina
- 595 Tishyenko Tatyana
- 596 Sobolev ??
- 597 Andin Nikolaj
- 598 Artemida Alexandr
- 599 Bazarov Alexandr
- 600 Chertov Oleg
- 601 Eližarov Maxim
- 602 Gherasiov Victor
- 603 Kablov Oleg
- 604 Kapitonov Alexej
- 605 Kovalyov Alexej
- 606 Kruzshilin Oleg
- 607 Lantsayev Vasilij
- 608 Lazurenkov Sergei
- 609 Lebedov Dmitrii
- 610 Mironyuk Andrej
- 611 Polzumov Vladislav
- 612 Tissin Andrei

SVK - Slovakia

- 641 Birvonova Miriam
- 642 Hochschornerova Eva
- 643 Kapisovska Svetlana
- 644 Medovcikova Kristina
- 645 Petranova Jana
- 646 Blaho Jan
- 647 Brodsky Ladislav
- 648 Jankech Gabriel
- 649 Kasuba Lucian
- 650 Kiss Roman
- 651 Kuzel Rastislav
- 652 Martiny Martin
- 653 Opalka Richard
- 654 Pales Andrej
- 655 Simocko Radovan
- 656 Straka Peter
- 657 Stribrnsky Martin

SUI - Swiss

- 661 Bachmann Adrian
- 662 Rohr Mathias

SLO - Slovenia

- 621 Bratasevec Tina
- 622 Culibrk Dunja
- 623 Kozel Lea
- 624 Labignan Sandra
- 625 Strupar Zaneta
- 626 Dodic Mitja
- 627 Jakomin Dejan
- 628 Planinc Marjan
- 629 Renner Marko



International
Canoe Federation

5th WORLD JUNIOR
CANOE
CHAMPIONSHIPS



29.7. - 1.8. 1993
RACICE
CZECH REPUBLIC



Czech Canoe
Union

STARTOVNÍ LISTINA / START LIST

LIST OF COMPETITORS

POL - Poland

501 Gregorowicz Kinga
502 Kreczman Iwona
503 Opara Monika
504 Pastuszka Aneta
505 Slota Karolina
506 Szeszko Joanna
507 Aleksandrowicz Waldemar
508 Kondracki Edward
509 Lakomy Pawel
510 Lorenz Tomasz
511 Markiewicz Jaroslaw
512 Midloch Pawel
513 Midloch Piotr
514 Pietrzak Artur
515 Porowski Wlodzimierz
516 Rudny Arkadiusz
517 Watkowski Norbert
518 Wolff Pawel
519 Zajackowski Slawomir
520 Zurek Ireneusz

ROM - Romania

551 Borgeri Florentina
552 Cristoa Mirola
553 Ionita Racula
554 Nina Mihaela
555 Pirvu Carmen
556 Radu Blena
557 ?? ??
558 Andrei Mihaita
559 Baban Bugen
560 Baban Marian
561 Ciucu Marin
562 Condrache Mihail
563 Cosma Lucian
564 Enache Mihail
565 Glavan Marcel
566 Grigore Sami
567 Hanches Ioan
568 Huidu Florian
569 Luca Marian
570 Mardale Cristian
571 Sirbu Marian

POR - Portugal

531 Azevedo Julieta
532 Silva Susana
533 Almeida Carlos
534 Fazenda Diogo
535 Oliveira Rui
536 Reis Helio
537 Silva Ludgero
538 Sousa Jose
539 Varela Sergio

RSA - South Africa

581 Caldwell Stuart
582 Du Toit Sakkie
583 Leonard Danie
584 Schoeman Stephan
585 Stenhouse Matthew
586 Willis Russell



COMPUTER SYSTEMS



Computer Office Equipment



STARTOVNÍ LISTINA / START LIST

LIST OF COMPETITORS

SWE - Sweden

671 Augustsson Lisen
672 Hamrin Jenny
673 Karlsson Anna
674 Karlsson Therese
675 Linder Ulrica
676 Nyman Ylva
677 Adlers Daniel
678 Berglund Mats
679 Edlund Daniel
680 Haglund Hans
681 Myrman Royne
682 Nilsson Henrik
683 Oscarsson Markus
684 Oscarsson Mattias
685 Wangelin Christian

TKM - Turkmenistan

691 Nouriyev Akhmet
692 Provotorov Dmitri
693 Chevtchouk Alexandre

UKR - Ukraine

701 Duknanina Elena
702 Kovalenko Anna
703 Litchman Tatiana
704 Tchaytchouk Alevtina
705 Yurtchenko Ekaterina
706 Berzin Serguei
707 Berzin Serguei
708 Dvouljat Serguei
709 Korenyuk Valentin
710 Kovaltchouk Andrei
711 Kutcherenko Serguei
712 Litvinenko Alexandr
713 Navitnyi Oleg
714 Pavlov Vyatcheslav
715 Sivko Alexandr
716 Tchernenko Serguei
717 Tchounyak Alexandr
718 Vdovitchenko Vladimir
719 Yakovtchenko Vladimir
720 Zhembrovski Serguei

USA - U.S.A.

731 Ashford Elizabeth
732 Beyer Tara
733 Goodrow Genevieve
734 White Olivia
735 Batlik Vaclav
736 Farnum Jim
737 Johnson Nate
738 Mowat Kai
739 Osusky Juraj
740 Rocheleau Brian
741 Watanabe Chuck

STARTOVNÍ LISTINA / START LIST

LIST OF COMPETITORS

KAZ - Kazachstan

776 Egorov Evgenij
778 Kirnenko Sergej
771 Loseva Olga
777 Sobcinskij Dimitrij
772 Parfjonova Elena
773 Muravjova Natalja
774 Voseva Olga
775 Caileva Elena

FIN - Finland

791 Latvamaki Kimmo
792 Keso Mikko
793 Ruokonen Riku
794 Winqvist Simon
795 Mikkonen Kalle



International
Canoe Federation

5th WORLD JUNIOR
CANOE
CHAMPIONSHIPS



29.7. - 1.8. 1993
RAČICE
CZECH REPUBLIC



Czech Canoe
Union

VÝSLEDKOVÁ LISTINA / RESULT LIST

Datum/date 29.7.93

K1M 500 m

Junioren

Závod
Race

1

Rozjízdkva/Heat

1

Cas/Time 08:32

		250 m	Total
1	ESP (2) 202 Leal Carlos	51.52 (1)	1:45.95
2	SWE (9) 684 Oscarsson Mattias	53.44 (5) 01.92	1:47.58 01.63
3	RUS (3) 600 Chertov Oleg	51.84 (2) 00.32	1:48.08 02.13
4	ROM(5) 564 Enache Mihail	53.16 (4) 01.64	1:48.98 03.03
5	POR (1) 538 Sousa Jose	52.83 (3) 01.31	1:49.53 03.58
6	CAN (7) 108 Cobb Graham	53.71 (6) 02.19	1:52.24 06.29
7	GBR (8) 258 Tingay Stephen	54.81 (7) 03.29	1:55.80 09.85
8	EST (6) 216 Vello Raul	58.11 (9) 06.59	1:58.40 12.45
9	KOR (4) 397 Moon Chul Wook	57.12 (8) 05.60	1:58.71 12.76

1-2 ->SF rest ->R

Temperatur: -water 20 °C -air 17 °C Wind: 0.5m/sec 130°

Chief Official: John Leukemans (BEL)
Starters: Otto Tomiuc (ROM)

Course Umpires: Janssens (BEL) Navasart (ROM)
Finish Line judge: Gunter Byhan (GER)





International
Canoe Federation

5th WORLD JUNIOR
CANOE
CHAMPIONSHIPS



29.7. - 1.8. 1993
RACICE
CZECH REPUBLIC



Czech Canoe
Union

VÝSLEDKOVÁ LISTINA / RESULT LIST

Datum/date 29.7.93

K1M 500 m Junioren Závod/Race **2**
Rozjízdka/Heat 2 Cas/Time 08:41

		250 m	Total
1	HUN (8) 320 Bauer Marton		1:43.87
2	GER (2) 279 Ulm Stefan		1:44.49 00.62
3	BEL (6) 45 Plomteux Laurens		1:44.77 00.90
4	BLR (4) 57 Degtiariov Vladislav		1:45.13 01.26
5	FIN (9) 791 Latvamaki Kimmo		1:47.08 03.21
6	RSA (7) 586 Willis Russell		1:51.33 07.46
7	USA (3) 741 Watanabe Chuck		1:54.48 10.61
8	CZE (1) 159 Vanicek Vit		1:59.79 15.92

1-2 ->SF rest ->R

Temperatur: -water 20 °C -air 17 °C Wind: 0.5m/sec 130°

Chief Official: John Leukemans (BEL) Course Umpires: Horvath (HUN) Chielewska (POL)
Starters: Otto Tomiuc (ROM) Finish Line judge: Gunter Byhan (GER)



COMPUTER SYSTEMS



Complete Office Equipment





International
Canoe Federation

5th WORLD JUNIOR
CANOE
CHAMPIONSHIPS



29.7. - 1.8. 1993
RAČICE
CZECH REPUBLIC



Czech Canoe
Union

VÝSLEDKOVÁ LISTINA / RESULT LIST

Datum/date 29.7.93

K1M 500 m

Junioren

Rozjízdka/Heat

3

Cas/Time 08:51

Závod
Race

3

		250 m	Total
1	AUS (3) 20 Evans Peter	50.31 (1)	1:46.55
2	KAZ (9) 776 Egorov Evgenij	53.17 (3) 02.86	1:49.91 03.36
3	MLD(4) 462 Babitch Jeuri	51.69 (2) 01.38	1:50.04 03.49
4	JPN (6) 382 Riyuuki Shiraiwa	55.42 (7) 05.11	1:52.98 06.43
5	LTU (7) 431 Varnas Tomas	55.09 (6) 04.78	1:53.03 06.48
6	BRA (1) 71 Lopes Denis Ferre	54.05 (4) 03.74	1:53.30 06.75
7	MEX(8) 446 Heinze Ralph	55.81 (8) 05.50	1:54.38 07.83
8	ISR (5) 342 Hardoof Ronen	56.30 (9) 05.99	1:54.59 08.04
9	NED (2) 476 Kossen Wouter	54.32 (5) 04.01	1:59.23 12.68

1-2 ->SF rest ->R

Temperatur: -water 20 °C -air 17 °C Wind: 0.5m/sec 130°

Chief Official: John Leukemans (BEL)

Course Umpires: Amper D. (ISR) Bland P. (GBR)

Starters: Otto Tomiuc (ROM)

Finish Line judge: Gunter Byhan (GER)





International
Canoe Federation

5th WORLD JUNIOR
CANOE
CHAMPIONSHIPS



29.7. - 1.8. 1993
RACICE
CZECH REPUBLIC



Czech Canoe
Union

VÝSLEDKOVÁ LISTINA / RESULT LIST

Datum/date 29.7.93

K1M 500 m

Junioren

Závod
Race

4

Rozjízdky/Heat

4

Cas/Time 09:01

		250 m	Total
1	POL (4) 515 Porowski Wlodzimierz	51.14 (1)	1:46.94
2	FRA (3) 237 Robert Yann	52.67 (3) 01.53	1:47.76 00.82
3	SVK (2) 655 Simocko Radovan	53.83 (5) 02.69	1:47.93 00.99
4	LAT (6) 412 Zalupe Kristaps	51.58 (2) 00.44	1:48.20 01.26
5	DEN (5) 179 Svenningen Claus	53.17 (4) 02.03	1:50.51 03.57
6	SUI (1) 662 Rohr Mathias	54.82 (6) 03.68	1:51.28 04.34
7	GRE (8) 301 Sideropulos Panaiotis	1:00.25 (7) 09.11	1:55.34 08.40

1-2 ->SF rest ->R

Temperatur: -water 20 °C -air 17 °C Wind: 1.3m/sec 160°

Chief Official: John Leukemans (BEL) Course Umpires: Janssens (BEL) Navasart (ROM)
Starters: Otto Tomiuc (ROM) Finish Line judge: Gunter Byhan (GER)



COMPUTER SYSTEMS



Complete Office Equipment



International
Canoe Federation

5th WORLD JUNIOR
CANOE
CHAMPIONSHIPS



29.7. - 1.8. 1993
RAČICE
CZECH REPUBLIC



Czech Canoe
Union

VÝSLEDKOVÁ LISTINA / RESULT LIST

Datum/date 29.7.1993

Závod
Race **5**

NO RACE

SPORTIS
Sport Information System
PRESS CLUB

20
telekomunikace



COMPUTER SYSTEMS

SAN-TEAM

O.E.
Complete Office Equipment

SPORTIS
Sport Information System
PRESS CLUB





International
Canoe Federation

5th WORLD JUNIOR
CANOE
CHAMPIONSHIPS



29.7. - 1.8. 1993
RACICE
CZECH REPUBLIC



VÝSLEDKOVÁ LISTINA / RESULT LIST

Datum/date 29.7.93

C1M 500 m Junioren Závod/Race **6**
Rozjízdka/Heat 1 Cas/Time 09:23

			250 m	Total
1	HUN (2)	319 Balgovits Gabor	59.43 (3) 01.15	1:59.92
2	ESP (3)	207 Villar Jesus	58.28 (1)	2:00.67 00.75
3	POL (1)	508 Kondracki Edward	1:00.09 (4) 01.81	2:02.73 02.81
4	BUL (4)	89 Petrov Genaedi	58.77 (2) 00.49	2:05.50 05.58
5	GRE (5)	303 Terzithis Teofanis	1:01.68 (6) 03.40	2:06.12 06.20
6	LTU (6)	429 Paulauskas Dainius	1:00.47 (5) 02.19	2:08.98 09.06
7	POR (7)	535 Oliveira Rui	1:02.78 (7) 04.50	2:12.43 12.51

1-2 →SF rest →R

Temperatur: -water 20 °C -air 17 °C Wind: 1.6m/sec 180°

Chief Official: John Leukemans (BEL) Course Umpires: Amper D. (ISR) Bland P. (GBR)
Starters: Otto Tomiuc (ROM) Finish Line judge: Gunter Byhan (GER)



COMPUTER SYSTEMS



Complete Office Equipment





International
Canoe Federation

5th WORLD JUNIOR
CANOE
CHAMPIONSHIPS



29.7. - 1.8. 1993
RACICE
CZECH REPUBLIC



Czech Canoe
Union

VÝSLEDKOVÁ LISTINA / RESULT LIST

Datum/date 29.7.93

C1M 500 m

Junioren

Rozjízdká/Heat 2

Cas/Time 09:33

Závod
Race

7

		250 m	Total
1	ROM(7) 565 Glavan Marcel	58.50 (1)	1:59.96
2	BLR (6) 66 Zhookovskij Dmitrij	58.94 (2) 00.44	2:02.43 02.47
3	DEN (2) 178 Scales Carsten	1:00.75 (4) 02.25	2:04.96 05.00
4	RUS (4) 602 Gherasiov Victor	1:00.20 (3) 01.70	2:06.60 06.64
5	CZE (3) 142 Juttner Tomas	1:02.56 (5) 04.06	2:06.82 06.86
6	JPN (1) 381 Noritomo Shibuya	1:02.90 (6) 04.40	2:11.60 11.64

1-2 ->SF rest ->R

Temperatur: -water 20 °C -air 17 °C Wind: 1.6m/sec 180°

Chief Official: John Leukemans (BEL)

Course Umpires: Janssens (BEL) Navasart (ROM)

Starters: Otto Tomiuc (ROM)

Finish Line judge: Gunter Byhan (GER)



Complete Office Equipment





International
Canoe Federation

5th WORLD JUNIOR
CANOE
CHAMPIONSHIPS



29.7. - 1.8. 1993
RAČICE
CZECH REPUBLIC



Czech Canoe
Union

VÝSLEDKOVÁ LISTINA / RESULT LIST

Datum/date 29.7.93

C1M 500 m

Junioren

Rozjízdka/Heat 3

Cas/Time 09:40

Závod
Race 8

		250 m	Total
1	CRO (7) 123 Funtak Drazen	58.39 (1)	2:00.97
2	LAT (2) 408 Klava Ainars	1:01.36 (3) 02.97	2:02.01 01.04
3	CAN (5) 107 Buday Tamas	59.60 (2) 01.21	2:02.25 01.28
4	SVK (1) 654 Pales Andrej	1:02.34 (5) 03.95	2:11.26 10.29
5	EST (4) 213 Koiva Kaspar	1:04.21 (6) 05.82	2:13.93 12.96
6	KAZ (3) 778 Kirnenko Sergej	1:04.43 (7) 06.04	2:14.26 13.29
7	MEX (6) 443 Castaneda Jose Luis	1:01.90 (4) 03.51	2:17.55 16.58

1-2 ->SF rest ->R

Temperatur: -water 20 °C -air 17 °C Wind: 1.0m/sec 210°

Chief Official: John Leukemans (BEL) Course Umpires: Horvath (HUN) Chielewska (POL)
Starters: Otto Tomiuc (ROM) Finish Line judge: Gunter Byhan (GER)



COMPUTER SYSTEMS



O.E.

Complete Office Equipment





International
Canoe Federation

5th WORLD JUNIOR
CANOE
CHAMPIONSHIPS



29.7. - 1.8. 1993
RAČICE
CZECH REPUBLIC



Czech Canoe
Union

VÝSLEDKOVÁ LISTINA / RESULT LIST

Datum/date 29.7.93

C1M 500 m

Junioren

Rozjízdká/Heat 4

Cas/Time 09:52

Závod
Race

9

			250 m	Total
1	GER (1) 267	Gille Christian	57.07 (1)	1:58.25
2	FRA (5) 232	Lavigne Yannick	57.29 (2) 00.22	2:01.88 03.63
3	ITA (2) 356	Bedin Andrea	1:00.64 (4) 03.57	2:02.81 04.56
4	GBR (4) 254	Love Jonathan	1:04.15 (5) 07.08	2:06.60 08.35
5	KOR (7) 393	Kim Soon Suk	1:05.32 (6) 08.25	2:13.03 14.78
6	UKR (6) 712	Litvinenko Alexandr	57.89 (3) 00.82	2:18.08 19.83
7	SLO (3) 627	Jakomin Dejan	1:14.20 (7) 17.13	2:35.27 37.02

1-2 →SF rest →R

Temperatur: -water 20 °C -air 17 °C Wind: 1.0m/sec 210°

Chief Official: John Leukemans (BEL) Course Umpires: Amper D. (ISR) Bland P. (GBR)
Starters: Otto Tomiuc (ROM) Finish Line judge: Gunter Byhan (GER)



COMPUTER SYSTEMS

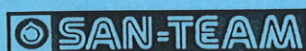



International
Canoe Federation

5th WORLD JUNIOR
CANOE
CHAMPIONSHIPS



29.7. - 1.8. 1993
RAČICE
CZECH REPUBLIC



Czech Canoe
Union

VÝSLEDKOVÁ LISTINA / RESULT LIST

Datum/date 29.7.93

K1W 500 m

Junioren

Závod

10

Rozjízdky/Heat

1

Cas/Time 10:02

Race

		250 m	Total
1	GER (3) 262 Mucke Manuela	56.68 (1)	1:57.41
2	ESP (1) 191 Aramburu Izaskum	58.28 (5) 01.60	1:57.60 00.19
3	SWE (8) 673 Karlsson Anna	57.78 (3) 01.10	1:58.46 01.05
4	HUN (9) 311 Bankuti Judit	57.95 (4) 01.27	1:59.68 02.27
5	POL (2) 505 Slota Karolina	56.90 (2) 00.22	2:00.47 03.06
6	AUS (5) 12 Nossiter Yanda	1:00.86 (6) 04.18	2:05.73 08.32
7	FRA (6) 221 Agnes Isabelle	1:03.82 (8) 07.14	2:11.32 13.91
8	LTU (4) 421 Simonaviciute V.	1:03.66 (7) 06.98	2:12.84 15.43

1-2 ->SF rest ->R

Temperatur: -water 20 °C -air 17 °C Wind: 2.2m/sec 180°

Chief Official: John Leukemans (BEL) Course Umpires: Janssens (BEL) Navasart (ROM)
Starters: Otto Tomiuc (ROM) Finish Line judge: Gunter Byhan (GER)



COMPUTER SYSTEMS



O.E.

Complete Office Equipment





International
Canoe Federation

5th WORLD JUNIOR
CANOE
CHAMPIONSHIPS



29.7. - 1.8. 1993
RAČICE
CZECH REPUBLIC



Czech Canoe
Union

VÝSLEDKOVÁ LISTINA / RESULT LIST

Datum/date 29.7.93

K1W 500 m

Junioren

Rozjízdka/Heat 2

Cas/Time 10:14

Závod
Race

11

		250 m	Total
1	BLR (7) 51 Bet Elena	58.72 (1)	2:03.79
2	UKR (6) 702 Kovalenko Anna	1:00.81 (2) 02.09	2:06.26 02.47
3	AUT (3) 31 Schlitzer Petra	1:04.60 (3) 05.88	2:13.13 09.34
4	CRO (9) 121 Kriskovic Ervina	1:05.20 (4) 06.48	2:14.58 10.79
5	EST (4) 211 Merila Age	1:06.52 (6) 07.80	2:16.69 12.90
6	NED (1) 471 v.d. Endt Marion	1:05.69 (5) 06.97	2:18.82 15.03
7	GRE (8) 291 Georgiadou Roza	1:07.56 (7) 08.84	2:20.77 16.98

1-2 ->SF rest ->R

Temperatur: -water 20 °C -air 17 °C Wind: 2.2m/sec 180°

Chief Official: John Leukemans (BEL)

Course Umpires: Horvath (HUN) Chielewska (POL)

Starters: Otto Tomiuc (ROM)

Finish Line judge: Gunter Byhan (GER)



COMPUTER SYSTEMS



Complete Office Equipment





International
Canoe Federation

5th WORLD JUNIOR
CANOE
CHAMPIONSHIPS



29.7. - 1.8. 1993
RACICE
CZECH REPUBLIC



VÝSLEDKOVÁ LISTINA / RESULT LIST

Datum/date 29.7.93

K1W 500 m

Junioren

Rozjízdka/Heat 3

Cas/Time 10:22

Závod
Race

12

			250 m	Total
1	SVK (6)	644 Medovcikova Kristina	1:00.15 (2) 00.39	2:00.56
2	BUL (1)	81 Zamfirova Nely	59.76 (1)	2:02.71 02.15
3	CAN (7)	103 Mckenzie Laura	1:00.53 (3) 00.77	2:03.81 03.25
4	GBR (4)	245 Hemmings Anna	1:00.92 (4) 01.16	2:04.35 03.79
5	POR (2)	532 Silva Susana	1:01.30 (5) 01.54	2:06.11 05.55
6	JPN (8)	373 Sayuri Maruyama	1:01.96 (6) 02.20	2:07.32 06.76
7	KAZ (3)	771 Loseva Olga	1:04.27 (7) 04.51	2:12.76 12.20
8	KOR (5)	392 Park Won Kyung	1:06.08 (8) 06.32	2:16.38 15.82

1-2 →SF rest →R

Temperatur: -water 20 °C -air 20 °C Wind: 1.8m/sec 170°

Chief Official: John Leukemans (BEL)

Course Umpires: Amper D. (ISR) Bland P. (GBR)

Starters: Otto Tomiuc (ROM)

Finish Line judge: Gunter Byhan (GER)



Complete Office Equipment





International
Canoe Federation

5th WORLD JUNIOR
CANOE
CHAMPIONSHIPS



29.7. - 1.8. 1993
RAČICE
CZECH REPUBLIC



Czech Canoe
Union

VÝSLEDKOVÁ LISTINA / RESULT LIST

Datum/date 29.7.93

K1W 500 m

Junioren

Rozjízdká/Heat 4

Cas/Time 10:30

Závod
Race

13

		250 m	Total
1	ROM(1) 553 Ionita Racula	57.73 (1)	1:57.65
2	CZE (4) 134 Hlucha Katerina	58.00 (2) 00.27	1:59.09 01.44
3	ISR (8) 341 Carmi Lior	58.88 (3) 01.15	2:00.92 03.27
4	MLD(2) 461 Nenno Anna	59.76 (4) 02.03	2:02.70 05.05
5	USA (3) 732 Beyer Tara	1:00.03 (5) 02.30	2:03.20 05.55
6	ARG (7) 1 Donadio Valeria	1:00.64 (6) 02.91	2:05.73 08.08
7	NOR (5) 483 Halano May Lise	1:01.24 (7) 03.51	2:07.41 09.76

1-2 ->SF rest ->R

Temperatur: -water 20 °C -air 20 °C Wind: 1.4 m/sec 170°

Chief Official: John Leukemans (BEL)

Course Umpires: Janssens (BEL) Navasart (ROM)

Starters: Otto Tomiuc (ROM)

Finish Line judge: Gunter Byhan (GER)



COMPUTER SYSTEMS



Complete Office Equipment





International
Canoe Federation

5th WORLD JUNIOR
CANOE
CHAMPIONSHIPS



29.7. - 1.8. 1993
RAČICE
CZECH REPUBLIC



Czech Canoe
Union

VÝSLEDKOVÁ LISTINA / RESULT LIST

Datum/date 29.7.93

K2M 500 m Junioiren Závod Race **14**
Rozjízdká/Heat 1 Cas/Time 10:43

			250 m	Total
1	BUL (4)	85 Karadjov Petar 86 Merkov Petar	47.35 (1)	1:37.91
2	ITA (6)	361 Majocchi Jacopo 362 Mangani Flavio	47.84 (2) 00.49	1:39.20 01.29
3	DEN (7)	176 Olsen Rene 175 Korshin Andre	49.05 (3) 01.70	1:42.47 04.56
4	MEX (8)	446 Heinze Ralph 444 Dominguez Emilio	50.09 (5) 02.74	1:44.48 06.57
5	AUS (5)	22 Prosser Greg 16 Chilvers Mike	49.65 (4) 02.30	1:44.49 06.58
6	USA (3)	738 Mowat Kai 736 Farnum Jim	50.75 (6) 03.40	1:45.30 07.39
7	GRE (1)	301 Sideropulos Panaiotis 299 Montanaris Stelios	51.14 (7) 03.79	1:46.24 08.33
8	MLD (2)	463 Vitt Igori 462 Babitch Jeuri	52.73 (8) 05.38	1:48.37 10.46

1-3 ->SF rest ->R

Temperatur: -water 20 °C -air 22 °C Wind: 1.1m/sec 150°

Chief Official: John Leukemans (BEL) Course Umpires: Horvath (HUN) Chielewska (POL)
Starters: Otto Tomiuc (ROM) Finish Line judge: Gunter Byhan (GER)



Complete Office Equipment





International
Canoe Federation

5th WORLD JUNIOR
CANOE
CHAMPIONSHIPS



29.7. - 1.8. 1993
RAČICE
CZECH REPUBLIC



VÝSLEDKOVÁ LISTINA / RESULT LIST

Datum/date 29.7.93

K2M 500 m

Junioren

Rozjízdka/Heat 2

Cas/Time 10:51

Závod
Race

15

		250 m	Total
1	BLR (2) 56 Borisik Piotr 63 Povalanskij Valerij	46.74 (1)	1:37.77
2	BEL (6) 45 Plomteux Laurens 47 Stevens David	48.50 (3) 01.76	1:38.65 00.88
3	CZE (8) 153 Sarka Jan 141 Hejda Premysl	48.28 (2) 01.54	1:39.63 01.86
4	KAZ (1) 776 Egorov Evgenij 777 Sobcinskij Dimitrij	48.78 (4) 02.04	1:41.12 03.35
5	UKR (4) 716 Tchernenko Serguei 713 Navitnyi Oleg	49.22 (5) 02.48	1:43.10 05.33
6	GBR (7) 257 Smith David 251 Hemmings Brian	52.51 (6) 05.77	1:47.61 09.84
7	ARG (3) 7 Suaya Pablo 3 Basualto Ariel	53.88 (7) 07.14	1:54.52 16.75
8	SLO (5) 626 Dodic Mitja 628 Planinc Marjan	1:00.31 (8) 13.57	2:08.88 31.11

1-3 ->SF rest ->R

Temperatur: -water 20 °C -air 22 °C Wind: 1.1m/sec 150°

Chief Official: John Leukemans (BEL)

Course Umpires: Amper D. (ISR) Bland P. (GBR)

Starters: Otto Tomiuc (ROM)

Finish Line judge: Gunter Byhan (GER)



COMPUTER SYSTEMS





International
Canoe Federation

5th WORLD JUNIOR
CANOE
CHAMPIONSHIPS



29.7. - 1.8. 1993
RAČICE
CZECH REPUBLIC



Czech Canoe
Union

VÝSLEDKOVÁ LISTINA / RESULT LIST

Datum/date 29.7.93

K2M 500 m

Junioren

Rozjízdká/Heat 3

Cas/Time 11:02

Závod

16

Race

		250 m	Total
1	SWE (2) 682 Nilsson Henrik 683 Oscarsson Markus	47.60 (2) 00.48	1:37.95
2	SVK (6) 651 Kuzel Rastislav 655 Simocko Radovan	49.27 (6) 02.15	1:38.47 00.52
3	LTU (7) 424 Gerulskis Edmundas 422 Balciunas Egidijus	48.08 (4) 00.96	1:38.58 00.63
4	ROM(4) 571 Sirbu Marian 562 Condrache Mihail	47.12 (1)	1:38.86 00.91
5	POL (5) 507 Aleksandrowicz W. 511 Markiewicz Jaroslaw	47.78 (3) 00.66	1:40.60 02.65
6	RSA (8) 581 Caldwell Stuart 582 Du Toit Sakkie	48.53 (5) 01.41	1:41.13 03.18
7	SUI (1) 662 Rohr Mathias 661 Bachmann Adrian	52.18 (7) 05.06	1:42.41 04.46
8	BRA (3) 72 Lozz Ricardo 73 Mattiello Bruno Lebr.	53.06 (8) 05.94	1:53.57 15.62

1-3 ->SF rest ->R

Temperatur: -water 20 °C -air 22 °C Wind: 1.1m/sec 150°

Chief Official: John Leukemans (BEL) Course Umpires: Janssens (BEL) Navasart (ROM)
Starters: Otto Tomiuc (ROM) Finish Line judge: Gunter Byhan (GER)



telekomunikace



COMPUTER SYSTEMS



Complete Office Equipment





International
Canoe Federation

5th WORLD JUNIOR
CANOE
CHAMPIONSHIPS



29.7. - 1.8. 1993
RAČICE
CZECH REPUBLIC



VÝSLEDKOVÁ LISTINA / RESULT LIST

Datum/date 29.7.93

K2M 500 m

Junioren

Rozjízdká/Heat 4

Cas/Time 11:20

Závod
Race **17**

		250 m		Total
1	HUN (1)	318 Almasi Peter 334 Szabo Roland	46.08 (1)	1:35.95
2	LAT (4)	404 Balabolins Kaspars 406 Buncis Edgars	46.41 (2) 00.33	1:36.17 00.22
3	RUS (5)	597 Andin Nikolaj 603 Kablov Oleg	47.02 (3) 00.94	1:39.25 03.30
4	POR (3)	539 Varela Sergio 533 Almeida Carlos	48.99 (5) 02.91	1:40.51 04.56
5	NOR (7)	487 Gjeroe Andreas 488 Rudolfsen Frooe	48.44 (4) 02.36	1:42.99 07.04
6	TKM (2)	693 Chevtchouk Alexandre 692 Provotorov Dmitri	49.76 (6) 03.68	1:45.84 09.89
7	JPN (6)	385 Yasuo Miyake 378 Kazunori Tagami	50.81 (7) 04.73	1:48.20 12.25

1-3 ->SF rest ->R

Temperatur: -water 20 °C -air 24 °C Wind: 0.0m/sec

Chief Official: John Leukemans (BEL)

Course Umpires: Horvath (HUN) Chielewska (POL)

Starters: Otto Tomiuc (ROM)

Finish Line judge: Gunter Byhan (GER)



COMPUTER SYSTEMS



Complete Office Equipment





International
Canoe Federation

5th WORLD JUNIOR
CANOE
CHAMPIONSHIPS



29.7. - 1.8. 1993
RAČICE
CZECH REPUBLIC



Czech Canoe
Union

VÝSLEDKOVÁ LISTINA / RESULT LIST

Datum/date 29.7.93

K2M 500 m Junioren Závod Race **18**
Rozjízdka/Heat 5 Cas/Time 11:30

		250 m	Total
1	GER (6) 272 Lehnert Sven 277 Schmiech Daniel	47.62 (1)	1:38.34
2	ESP (3) 201 Gonzales Jovino 204 Merchan Emilio	48.06 (2) 00.44	1:39.25 00.91
3	FRA (1) 238 Vossion Damien 231 Huguet Cyril	48.50 (3) 00.88	1:40.15 01.81
4	AUT (7) 32 Hinterhofer Martin 33 Stollnberger Markus	49.21 (4) 01.59	1:42.97 04.63
5	CAN (5) 116 Smith Dave 109 Illsley Scott	49.76 (5) 02.14	1:43.30 04.96
6	KOR (4) 394 Kim Yong Kyo 395 Lee Kyung Soo	50.53 (6) 02.91	1:44.64 06.30
7	EST (2) 216 Vello Raul 214 Lelov Toomas	51.85 (7) 04.23	1:48.36 10.02

1-3 ->SF rest ->R

Temperatur: -water 20 °C -air 24 °C Wind: 0.0m/sec

Chief Official: John Leukemans (BEL) Course Umpires: Amper D. (ISR) Bland P. (GBR)
Starters: Otto Tomiuc (ROM) Finish Line judge: Gunter Byhan (GER)



COMPUTER SYSTEMS



Complete Office Equipment





International
Canoe Federation

5th WORLD JUNIOR
CANOE
CHAMPIONSHIPS



29.7. - 1.8. 1993
RAČICE
CZECH REPUBLIC



Czech Canoe
Union

VÝSLEDKOVÁ LISTINA / RESULT LIST

Datum/date 29.7.93

C2M 500 m

Junioren

Závod
Race

19

Rozjízdka/Heat

1

Cas/Time 11:40

			250 m	Total
1	HUN (6)	324 Gyore Attila 322 Csikos Gergely	53.39 (1)	1:50.74
2	GER (1)	270 Hesse Jan 281 Zeisner Daniel	54.76 (3) 01.37	1:51.66 00.92
3	BLR (8)	60 Kirilenko Victor 68 Zujev Vitalij	53.72 (2) 00.33	1:52.05 01.31
4	CZE (7)	156 Sterba Petr 147 Kozelsky David	55.42 (4) 02.03	1:53.44 02.70
5	FRA (5)	233 Moreaux Denis 234 Normand Samuel	56.96 (5) 03.57	1:57.47 06.73
6	USA (3)	737 Johnson Nate 735 Batlik Vaclav	58.28 (6) 04.89	2:01.12 10.38
7	POR (4)	535 Oliveira Rui 536 Reis Helio	58.77 (7) 05.38	2:08.22 17.48

1-3 ->SF rest ->R

Temperatur: -water 20 °C -air 24 °C Wind: 0.0m/sec

Chief Official: John Leukemans (BEL)

Course Umpires: Janssens (BEL) Navasart (ROM)

Starters: Otto Tomiuc (ROM)

Finish Line judge: Gunter Byhan (GER)



COMPUTER SYSTEMS



Complete Office Equipment





International
Canoe Federation

5th WORLD JUNIOR
CANOE
CHAMPIONSHIPS



29.7. - 1.8. 1993
RAČICE
CZECH REPUBLIC



Czech Canoe
Union

VÝSLEDKOVÁ LISTINA / RESULT LIST

Datum/date 29.7.93

C2M 500 m

Junioren

Rozjízdká/Heat

2

Cas/Time 11:50

Závod
Race

20

		250 m	Total
1	BUL (5) 88 Nikolov Rumen 82 Angelov Atanas	53.77 (1)	1:53.13
2	UKR (1) 717 Tchounyak Alexandr 710 Kovaltchouk Andrei	55.86 (2) 02.09	1:54.74 01.61
3	LAT (4) 409 Kovalovs Sergejs 410 Lagzdins Valentins	56.24 (3) 02.47	1:57.01 03.88
4	MEX (3) 443 Castaneda Jose Luis 442 Castaneda Benjamin	57.89 (4) 04.12	1:58.10 04.97
5	GBR (2) 248 Crowther Stuart 253 Lane Malcolm	58.66 (5) 04.89	1:59.29 06.16
6	EST (6) 215 Rumm Ranno 212 Hollo Mihkel	1:03.27 (6) 09.50	2:12.40 19.27

1-3 →SF rest →R

Temperatur: -water 20 °C -air 24 °C Wind: 0.8m/sec 308°

Chief Official: John Leukemans (BEL) Course Umpires: Horvath (HUN) Chielewska (POL)
Starters: Otto Tomiuc (ROM) Finish Line judge: Gunter Byhan (GER)



COMPUTER SYSTEMS





International
Canoe Federation

5th WORLD JUNIOR
CANOE
CHAMPIONSHIPS



29.7. - 1.8. 1993
RACICE
CZECH REPUBLIC



Czech Canoe
Union

VÝSLEDKOVÁ LISTINA / RESULT LIST

Datum/date 29.7.93

C2M 500 m

Junioren

Rozjízdky/Heat 3

Cas/Time 12:03

Závod
Race **21**

			250 m	Total
1	ROM(5)	565 Glavan Marcel 566 Grigore Sami	53.61 (1)	1:49.46
2	ESP (1)	207 Villar Jesus 206 Perez Gustavo	54.76 (2) 01.15	1:50.87 01.41
3	RUS (4)	605 Kovalyov Alexandr 606 Kruzshilin Oleg	55.03 (3) 01.42	1:54.11 04.65
4	POL (2)	512 Midloch Pawel 513 Midloch Piotr	55.58 (4) 01.97	2:00.39 10.93
5	LTU (6)	430 Polomosnov Andrej 427 Medvedev Konstantin	59.26 (5) 05.65	2:03.18 13.72
6	JPN (3)	375 Eiji Uejyo 386 Yoshimi Hosotani	1:03.16 (6) 09.55	2:12.93 23.47

1-3 ->SF rest ->R

Temperatur: -water 20 °C -air 24 °C Wind: 0.8m/sec 308°

Chief Official: John Leukemans (BEL)

Course Umpires: Amper D. (ISR) Bland P. (GBR)

Starters: Otto Tomiuc (ROM)

Finish Line judge: Gunter Byhan (GER)



COMPUTER SYSTEMS



Complete Office Equipment





International
Canoe Federation

5th WORLD JUNIOR
CANOE
CHAMPIONSHIPS



29.7. - 1.8. 1993
RAČICE
CZECH REPUBLIC



Czech Canoe
Union

VÝSLEDKOVÁ LISTINA / RESULT LIST

Datum/date 29.7.93

K2W 500 m

Junioren

Rozjízdka/Heat

1

Cas/Time 12:11

Závod

Race

22

			250 m	Total
1	GER (1)	262 Mucke Manuela 263 Muller Heike	53.77 (1)	1:51.55
2	POL (7)	504 Pastuszka Aneta 503 Opara Monika	54.76 (3) 00.99	1:52.74 01.19
3	CAN (9)	105 Prince Karina 101 Furneaux Karen	54.49 (2) 00.72	1:53.29 01.74
4	FRA (2)	223 Clet Cecile 226 Metenier Linda	55.86 (4) 02.09	1:56.96 05.41
5	POR (4)	532 Silva Susana 531 Azevedo Julieta	57.23 (5) 03.46	1:59.79 08.24
6	AUS (3)	12 Nossiter Yanda 11 Marot Christy	58.93 (6) 05.16	1:59.84 08.29
7	KOR (8)	392 Park Won Kyung 391 Ji Mi Jun	1:01.57 (7) 07.80	2:03.92 12.37
8	CRO (5)	121 Kriskovic Ervina 122 Ribaric Marina	1:03.38 (8) 09.61	2:10.82 19.27
9	SLO (6)	623 Kozel Lea 621 Bratasevec Tina	1:09.54 (9) 15.77	2:23.72 32.17

1-3 ->SF rest ->R

Temperatur: -water 20 °C -air 24 °C Wind: 0.8m/sec 308°

Chief Official: John Leukemans (BEL) Course Umpires: Janssens (BEL) Navasart (ROM)
Starters: Otto Tomiuc (ROM) Finish Line judge: Gunter Byhan (GER)



COMPUTER SYSTEMS

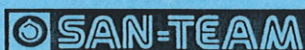

Complete Office Equipment



VÝSLEDKOVÁ LISTINA / RESULT LIST

Datum/date 29.7.93

K2W 500 m		Junioren	Závod Race	
Rozjízdky/Heat	2	Case/Time	12:20	23
			250 m	Total
1	UKR (9)	704 Tchaytchouk Alevtina 701 Duknanina Elena	54.54 (1)	1:52.64
2	RUS (7)	592 Kononova Yuliya 593 Minayeva Marina	55.31 (2) 00.77	1:52.81 00.17
3	CZE (4)	131 Borkovcova Sarka 133 Hekova Katerina	55.64 (3) 01.10	1:53.21 00.57
4	KAZ (1)	772 Parfjonova Elena 773 Muravjova Natalja	55.97 (4) 01.43	1:53.76 01.12
5	USA (8)	732 Beyer Tara 734 White Olivia	57.56 (5) 03.02	1:56.69 04.05
6	ITA (5)	351 Pedrazzi Silvia 352 Pellegrini Ilenia	58.83 (7) 04.29	1:56.74 04.10
7	ARG (3)	2 Maino Andrea 1 Donadio Valeria	58.22 (6) 03.68	1:58.80 06.16
8	NED (6)	472 Ham Pauline 473 Leeman Minouk	1:02.89 (8) 08.35	2:09.33 16.69
9	GRE (2)	291 Georgiadou Roza 293 Tsiupi Hrisula	1:05.58 (9) 11.04	2:13.79 21.15

1-3 →SF rest →R

Temperatur: -water 20 °C -air 24 °C Wind: 0.3 m/sec 150°

Chief Official: John Leukemans (BEL) Course Umpires: Horvath (HUN) Chielewska (POL)
Starters: Otto Tomiuc (ROM) Finish Line judge: Gunter Byhan (GER)



International
Canoe Federation

5th WORLD JUNIOR
CANOE
CHAMPIONSHIPS



29.7. - 1.8. 1993
RACICE
CZECH REPUBLIC



Czech Canoe
Union

VÝSLEDKOVÁ LISTINA / RESULT LIST

Datum/date 29.7.93

K2W 500 m

Junioren

Rozjízdky/Heat 3

Čas/Time 12:30

Závod
Race **24**

			250 m	Total
1	HUN (5)	314 Kovacs Katalin 312 Barocsi Andrea	53.00 (1)	1:49.24
2	BLR (1)	51 Bet Elena 52 Maslova Natalia	53.55 (2) 00.55	1:51.09 01.85
3	SWE (4)	674 Karlsson Therese 673 Karlsson Anna	54.76 (5) 01.76	1:51.43 02.19
4	ROM(6)	553 Ionita Racula 555 Pirvu Carmen	55.53 (6) 02.53	1:51.55 02.31
5	ESP (3)	193 Iglesias Andrea 195 Romero Antonia	54.59 (4) 01.59	1:53.21 03.97
6	SVK (2)	642 Hochschornerova Eva 641 Birvonova Miriam	53.99 (3) 00.99	1:53.86 04.62
7	GBR (7)	242 Fowler Suzanne 243 Giles Rebecca	56.13 (7) 03.13	1:55.51 06.27
8	NOR (9)	483 Halano May Lise 484 Knuosen Christine	56.68 (8) 03.68	1:58.98 09.74
9	JPN (8)	374 Yoshika Oonishi 372 Sanae Nakao	58.71 (9) 05.71	2:00.58 11.34

1-3 ->SF rest ->R

Temperatur: -water 20 °C -air 24 °C Wind: 0.5m/sec 70°

Chief Official: John Leukemans (BEL) Course Umpires: Amper D. (ISR) Bland P. (GBR)
Starters: Otto Tomiuc (ROM) Finish Line judge: Gunter Byhan (GER)



COMPUTER SYSTEMS



© Doppelherz Office Equipment



VÝSLEDKOVÁ LISTINA / RESULT LIST

Datum/date 29.7.93

K4M 500 m

Junioren

Závod
Race **25**

Rozjízdky/Heat 1

Cas/Time 12:41

			250 m	Total
1	RUS (5)	600 Chertov Oleg 612 Tissin Andrei 597 Andin Nikolaj 610 Mironyuk Andrej	42.95 (1)	1:28.46
2	FRA (8)	237 Robert Yann 229 Bocage Etienne 236 Richard Alban 235 Rebours Loic	43.67 (3) 00.72	1:28.53 00.07
3	SWE (6)	682 Nilsson Henrik 681 Myrman Royne 680 Haglund Hans 678 Berglund Mats	43.23 (2) 00.28	1:29.81 01.35
4	DEN (1)	172 Eilert Michael 177 Rasmussen Brian 179 Svenningen Claus 174 Heering Nicolai	46.36 (6) 03.41	1:29.98 01.52
5	ITA (7)	357 Blasi Andrea 366 Favalli Simone 368 Nardelli Ciro 363 Mate Davide	44.99 (4) 02.04	1:32.90 04.44
6	LTU (3)	424 Gerulskis Edmundas 422 Balciunas Egidijus 431 Varnas Tomas 428 Mironeko Ruslan	48.89 (8) 05.94	1:35.42 06.96
7	NED (2)	478 Visser Gido 475 de Rooy Maurits 476 Kossen Wouter 477 v.d. Pol Tobias	47.46 (7) 04.51	1:36.40 07.94
8	ARG (4)	7 Suaya Pablo 3 Basualto Ariel 4 Canepa Diego 5 Correa Javier	45.98 (5) 03.03	1:37.29 08.83

1-2 →SF rest →R

Temperatur: -water 20 °C -air 24 °C Wind: 0.9m/sec 160°

Chief Official: John Leukemans (BEL)

Course Umpires: Janssens (BEL) Navasart (ROM)

Starters: Otto Tomiuc (ROM)

Finish Line judge: Gunter Byhan (GER)



International
Canoe Federation

5th WORLD JUNIOR
CANOE
CHAMPIONSHIPS



29.7. - 1.8. 1993
RACICE
CZECH REPUBLIC



Czech Canoe
Union

VÝSLEDKOVÁ LISTINA / RESULT LIST

Datum/date 29.7.93

K4M 500 m Junioiren Závod **26**
Rozjízdka/Heat 2 Cas/Time 12:53 Race

		250 m	Total
1	GER (6) 268 Goedicke Robert 269 Heck Jens 276 Ruhl Marco 277 Schmiech Daniel	42.95 (1)	1:27.93
2	BLR (7) 56 Borisik Piotr 63 Povalanskij Valerij 57 Degtiariov Vladislav 64 Rubanov Gennadij	43.72 (2) 00.77	1:29.53 01.60
3	CZE (2) 153 Sarka Jan 141 Hejda Premysl 157 Termer Vlastimil 158 Tonder Tomas	44.27 (3) 01.32	1:29.69 01.76
4	SVK (8) 649 Kasuba Lucian 647 Brodsky Ladislav 650 Kiss Roman 656 Straka Peter	44.71 (4) 01.76	1:31.50 03.57
5	BEL (3) 44 Noppe Tom 42 Deslee Henk 43 Maesen Bob 48 Vandenbruwaene Leslie	45.31 (5) 02.36	1:33.65 05.72
6	USA (4) 736 Farnum Jim 738 Mowat Kai 741 Watanabe Chuck 739 Osusky Juraj	47.56 (7) 04.61	1:35.07 07.14
7	KOR (1) 398 Nam Sung Ho 394 Kim Yong Kyo 397 Moon Chul Wook 395 Lee Kyung Soo	47.07 (6) 04.12	1:39.25 11.32
8	GRE (5) 301 Sideropulos Panaiotis 299 Montanaris Stelios 302 Skoulariotis Georgos 300 Rountos Iorgos	50.47 (8) 07.52	1:44.52 16.59

1-2 ->SF rest ->R

Temperatur: -water 20 °C -air 24 °C Wind: 1.4m/sec 160°

Chief Official: John Leukemans (BEL) Course Umpires: Horvath (HUN) Chielewska (POL)
Starters: Otto Tomiuc (ROM) Finish Line judge: Gunter Byhan (GER)





International
Canoe Federation

5th WORLD JUNIOR
CANOE
CHAMPIONSHIPS



29.7. - 1.8. 1993
RAČICE
CZECH REPUBLIC



VÝSLEDKOVÁ LISTINA / RESULT LIST

Datum/date 29.7.93

K4M 500 m

Junioren

Rozjízdky/Heat 3

Čas/Time 13:00

Závod
Race

27

		250 m	Total
1	POL (8) 510 Lorenz Tomasz 518 Wolff Pawel 520 Zurek Ireneusz 509 Lakomy Pawel	44.54 (1)	1:31.23
2	RSA (1) 585 Stenhouse Matthew 586 Willis Russell 583 Leonard Danie 584 Schoeman Stephan	45.09 (2) 00.55	1:32.16 00.93
3	AUS (4) 14 Beresford-Peir Digby 19 Curry Billy 17 Clayton James 18 Croker Glen	47.89 (5) 03.35	1:35.18 03.95
4	LAT (7) 411 Petersons Gundars 405 Berzins Kaspars 412 Zalupe Kristaps 407 Greizis Ugis	47.18 (3) 02.64	1:36.17 04.94
5	GBR (5) 256 Sargeant Ian 249 Darby Dowman Paul 257 Smith David 251 Hemmings Brian	47.56 (4) 03.02	1:37.49 06.26
6	MEX (6) 448 Revuelta Raul 449 Sierra Luis 447 Heredia Rafael 444 Dominguez Emilio	50.20 (6) 05.66	1:40.40 09.17
7	JPN (3) 385 Yasuo Miyake 378 Kazunori Tagami 376 Hiroaki Matsumoto 384 Takaichi Nakatsu	50.69 (7) 06.15	1:44.46 13.23
8	SLO (2) 627 Jakomin Dejan 626 Dodic Mitja 628 Planinc Marjan 629 Rener Marko	56.68 (8) 12.14	1:57.98 26.75

1-2 ->SF rest ->R

Temperatur: -water 20 °C -air 24 °C Wind: 1.4m/sec 160°

Chief Official: John Leukemans (BEL) Course Umpires: Amper D. (ISR) Bland P. (GBR)
Starters: Otto Tomiuc (ROM) Finish Line judge: Gunter Byhan (GER)



COMPUTER SYSTEMS





International
Canoe Federation

5th WORLD JUNIOR
CANOE
CHAMPIONSHIPS



29.7. - 1.8. 1993
RACICE
CZECH REPUBLIC



VÝSLEDKOVÁ LISTINA / RESULT LIST

Datum/date 29.7.93

K4M 500 m Junioiren Závod/Race **28**
Rozjízdky/Heat 4 Cas/Time 13:16

			250 m	Total
1	HUN (6)	332 Storz Akos 327 Kovacs Akos 333 Storz Botond 317 Acs Tamas	42.46 (1)	1:27.17
2	ESP (1)	202 Leal Carlos 198 Cuinas Antonio 200 Garcia Carlos 197 Busto Manuel	43.12 (2) 00.66	1:29.03 01.86
3	POR (5)	539 Varela Sergio 534 Fazenda Diogo 538 Sousa Jose 533 Almeida Carlos	44.93 (5) 02.47	1:30.58 03.41
4	ROM(4)	558 Andrei Mihaita 560 Baban Marian 564 Enache Mihail 567 Hanches Ioan	43.83 (3) 01.37	1:30.64 03.47
5	NOR (7)	489 Sigurosen Stian 486 Fjeloheim Nils Olav 487 Gjeroe Andreas 488 Rudolfsen Frooe	44.55 (4) 02.09	1:31.89 04.72
6	FIN (8)	792 Keso Mikko 793 Ruokonen Riku 794 Winqvist Simon 795 Mikkonen Kalle	45.76 (6) 03.30	1:32.66 05.49
7	CAN (3)	112 Maksymiuk Daniel 108 Cobb Graham 116 Smith Dave 109 Illsley Scott	47.81 (8) 05.35	1:33.50 06.33
8	UKR (2)	715 Sivko Alexandr 707 Berzin Serguei 711 Kutcherenko Serguei 713 Navitnyi Oleg	46.52 (7) 04.06	1:33.53 06.36

1-2 ->SF rest ->R

Temperatur: -water 20 °C -air 24 °C Wind: 0.8m/sec 30°

Chief Official: John Leukemans (BEL) Course Umpires: Janssens (BEL) Navasart (ROM)
Starters: Otto Tomiuc (ROM) Finish Line judge: Gunter Byhan (GER)



COMPUTER SYSTEMS

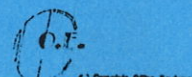



International
Canoe Federation

5th WORLD JUNIOR
CANOE
CHAMPIONSHIPS



29.7. - 1.8. 1993
RACICE
CZECH REPUBLIC



Czech Canoe
Union

VÝSLEDKOVÁ LISTINA / RESULT LIST

Datum/date 29.7.93

C4M 500 m

Junioren

Závod
Race

29

Rozjízdka/Heat

1

Cas/Time 13:22

			250 m	Total
1	HUN (5)	335 Telek Gabor 331 Redenszki Antal 328 Kurucz Zoltan 329 Marsalla Viktor	50.15 (3) 00.50	1:41.23
2	UKR (2)	717 Tchounyak Alexandr 710 Kovaltchouk Andrei 708 Dvoulyat Serguei 709 Korenyuk Valentin	49.65 (1)	1:41.34 00.11
3	POL (8)	519 Zajaczkowski Slawomir 517 Watkowski Norbert 512 Midloch Pawel 513 Midloch Piotr	49.93 (2) 00.28	1:42.22 00.99
4	RUS (3)	605 Kovalyov Alexandr 602 Gherasiov Victor 601 Elizarov Maxim 606 Kruzshilin Oleg	51.91 (6) 02.26	1:44.41 03.18
5	FRA (1)	230 Ethuin David 232 Lavigne Yannick 227 Assa Martin 228 Barbey Laurent	51.14 (4) 01.49	1:45.46 04.23
6	ITA (4)	367 Ventriglia Alessandro 364 Nardi Claudio 356 Bedin Andrea 358 Bonacina Antonio	51.74 (5) 02.09	1:52.32 11.09
7	LTU (7)	429 Paulauskas Dainius 427 Medvedev Konstantin 430 Polomosnov Andrej 426 Jonkus Mindaugas	53.72 (7) 04.07	1:56.83 15.60

1-2 ->F rest ->SF

Temperatur: -water 20 °C -air 24 °C Wind: 0.3m/sec 50°

Chief Official: John Leukemans (BEL)

Course Umpires: Horvath (HUN) Chielewska (POL)

Starters: Otto Tomiuc (ROM)

Finish Line judge: Gunter Byhan (GER)



COMPUTER SYSTEMS



Complete Office Equipment



VÝSLEDKOVÁ LISTINA / RESULT LIST

Datum/date 29.7.93

C4M 500 m		Juniořen			Závod Race	30
Rozjízdká/Heat	2		Cas/Time	13:30		
1	BUL (1)	88 Nikolov Ruměn 82 Angelov Atanas 83 Atanasov Dimitar 84 Atanasov Stanimir	250 m 47.08 (1)		Total 1:38.50	
2	GER (2)	267 Gille Christian 278 Tiedge Rene 280 Vesely Kay 266 Bebber Ricardo	48.28 (2) 01.20		1:39.49 00.99	
3	CZE (5)	149 Marisko Jan 137 Brecka Jan 142 Juttner Tomas 148 Machac Jan	50.37 (4) 03.29		1:42.24 03.74	
4	GRE (7)	305 Zachos Lukas 303 Terzithis Teofanis 294 Arapis Athanasios 297 Kiriazis Dimitrious	49.44 (3) 02.36		1:42.73 04.23	
5	BLR (4)	68 Zujev Vitalij 66 Zhookovskij Dmitrij 62 Markosian Mikhail 60 Kirilenko Victor	52.90 (5) 05.82		1:54.98 16.48	
6	JPN (6)	375 Eiji Uejyo 386 Yoshimi Hosotani 377 Hiroyuki Sato 380 Kiyoshige Saito	56.91 (6) 09.83		2:00.92 22.42	

1-2 ->F rest ->SF

Temperatur: -water 20 °C -air 24 °C Wind: 0.3m/sec 50°

Chief Official: John Leukemans (BEL)
Starters: Otto Tomiuc (ROM)

Course Umpires: Amper D. (ISR) Bland P. (GBR)
Finish Line judge: Gunter Byhan (GER)

VÝSLEDKOVÁ LISTINA / RESULT LIST

Datum/date 29.7.93

K1M 500 m

Junioren

Opr./řzda/Repetage 1

Cas/Time 16:00

Závod
Race **31**

			250 m	Total
1	FIN (3)	791 Latvamaki Kimmo	54.54 (6) 02.97	1:45.95
2	SVK (4)	655 Simocko Radovan	52.78 (4) 01.21	1:45.96 00.01
3	RUS (5)	600 Chertov Oleg	52.61 (3) 01.04	1:46.86 00.91
4	CZE (1)	159 Vanicek Vit	51.57 (1)	1:47.52 01.57
5	SUI (2)	662 Rohr Mathias	52.06 (2) 00.49	1:48.40 02.45
6	CAN (7)	108 Cobb Graham	53.22 (5) 01.65	1:48.93 02.98
7	MEX (8)	446 Heinze Ralph	55.25 (7) 03.68	1:52.11 06.16
8	JPN (6)	382 Riyuuki Shiraiwa	55.47 (8) 03.90	1:53.60 07.65
9	KOR (9)	397 Moon Chul Wook	57.23 (9) 05.66	1:56.30 10.35

1-3+the best 4th ->SF rest ->out

Temperatur: -water 21 °C -air 28 °C Wind: 0.3m/sec 50°

Chief Official: John Leukemans (BEL) Course Umpires: Janssens (BEL) Navasart (ROM)
Starters: Otto Tomiuc (ROM) Finish Line judge: Gunter Byhan (GER)

VÝSLEDKOVÁ LISTINA / RESULT LIST

Datum/date 29.7.93

K1M 500 m

Junioren

Opr.jízda/Repetage 2

Can/Time 16:11

Závod
Rnce **32**

		250 m	Total
1	BEL (5) 45 Plomteux Laurens	51.30 (1)	1:46.24
2	ROM(4) 564 Enache Mihail	52.07 (2) 00.77	1:47.81 01.57
3	LAT (6) 412 Zalupe Kristaps	52.34 (3) 01.04	1:48.76 02.52
4	RSA (7) 586 Willis Russell	54.54 (4) 03.24	1:50.80 04.56
5	GBR (2) 258 Tingay Stephen	56.19 (8) 04.89	1:51.66 05.42
6	LTU (3) 431 Varnas Tomas	55.31 (6) 04.01	1:52.71 06.47
7	ISR (9) 342 Hardoof Ronen	55.80 (7) 04.50	1:54.05 07.81
8	GRE (8) 301 Sideropulos Panaiotis	55.09 (5) 03.79	1:56.43 10.19

1-3+the best 4th ->SF rest ->out

Temperatur: -water 21 °C -air 28 °C Wind: 0.4m/sec 210°

Chief Official: John Leukemans (BEL) Course Umpires: Horvath (HUN) Chielewska (POL)
Starters: Otto Tomiuç (ROM) Finish Line judge: Gunter Byhan (GER)



International
Canoe Federation

5th WORLD JUNIOR
CANOE
CHAMPIONSHIPS



29.7. - 1.8. 1993
RACICE
CZECH REPUBLIC



Czech Canoe
Union

VÝSLEDKOVÁ LISTINA / RESULT LIST

Datum/date 29.7.93

K1M 500 m

Junioren

Opr.jfzda/Repetage 3

Cas/Time 16:21

Závod
Race **33**

		250 m	Total
1	BLR (4) 57 Degtiariov Vladislav	51.80 (1)	1:47.35
2	POR (6) 538 Sousa Jose	52.90 (3) 01.10	1:48.14 00.79
3	MLD(5) 462 Babitch Jeuri	51.96 (2) 00.16	1:48.20 00.85
4	DEN (3) 179 Svenningen Claus	53.17 (4) 01.37	1:49.10 01.75
5	USA (2) 741 Watanabe Chuck	54.93 (6) 03.13	1:51.36 04.01
6	BRA (7) 71 Lopes Denis Ferre	54.16 (5) 02.36	1:52.23 04.88
7	EST (8) 216 Vello Raul	56.47 (8) 04.67	1:54.71 07.36
8	NED (9) 476 Kossen Wouter	55.81 (7) 04.01	1:55.83 08.48

1-3+the best 4th ->SF rest ->out

Temperatur: -water 21 °C -air 28 °C Wind: 1.7m/sec 170°

Chief Official: John Leukemans (BEL) Course Umpires: Amper D. (ISR) Bland P. (GBR)
Starters: Otto Tomiuc (ROM) Finish Line judge: Gunter Byhan (GER)



COMPUTER SYSTEMS



VÝSLEDKOVÁ LISTINA / RESULT LIST

Datum/date 29.7.93

C1M 500 m

Junioren

Závod
Race

34

Opr./řzda/Repetage 1

Čas/Time 16:31

			250 m	Total
1	DEN (5)	178 Scales Carsten	59.16 (1)	2:01.35
2	SVK (4)	654 Pales Andrej	1:00.15 (2) 00.99	2:01.69 00.34
3	GRE (6)	303 Terzithis Teofanis	1:00.92 (3) 01.76	2:02.83 01.48
4	KAZ (7)	778 Kirnenko Sergej	1:02.89 (4) 03.73	2:10.74 09.39
5	KOR (3)	393 Kim Soon Suk	1:03.72 (5) 04.56	2:11.38 10.03
6	SLO (8)	627 Jakomin Dejan	1:09.38 (6) 10.22	2:25.99 24.64

1-3+the best 4th ->SF rest ->out

Temperatur: -water 21 °C -air 28 °C Wind: 1.7m/sec 210°

Chief Official: John Leukemans (BEL) Course Umpires: Janssens (BEL) Navasart (ROM)
Starters: Otto Tomiuc (ROM) Finish Line judge: Gunter Byhan (GER)



International
Canoe Federation

5th WORLD JUNIOR
CANOE
CHAMPIONSHIPS



29.7. - 1.8. 1993
RAČICE
CZECH REPUBLIC



Czech Canoe
Union

VÝSLEDKOVÁ LISTINA / RESULT LIST

Datum/date 29.7.93

C1M 500 m Junioren

Opr./řízda/Repetage 2

Cas/Time 16:43

Závod
Race **35**

		250 m	Total
1	RUS (4) 602 Gherasiov Victor	58.94 (2) 00.66	2:01.61
2	UKR (8) 712 Litvinenko Alexandr	58.28 (1)	2:02.49 00.88
3	POL (5) 508 Kondracki Edward	1:00.59 (3) 02.31	2:04.35 02.74
4	GBR (6) 254 Love Jonathan	1:01.02 (4) 02.74	2:05.67 04.06
5	JPN (3) 381 Noritomo Shibuya	1:02.73 (7) 04.45	2:08.42 06.81
6	EST (7) 213 Koiva Kaspar	1:02.34 (6) 04.06	2:08.75 07.14
7	POR (2) 535 Oliveira Rui	1:01.68 (5) 03.40	2:09.19 07.58

1-3+the best 4th ->SF rest ->out

Temperatur: -water 21 °C -air 28 °C Wind: 0.4m/sec 210°

Chief Official: John Leukemans (BEL) Course Umpires: Horvath (HUN) Chielewska (POL)
Starters: Otto Tomiuc (ROM) Finish Line judge: Gunter Byhan (GER)



COMPUTER SYSTEMS



Complete Office Equipment





International
Canoe Federation

5th WORLD JUNIOR
CANOE
CHAMPIONSHIPS



29.7. - 1.8. 1993
RAČICE
CZECH REPUBLIC



Czech Canoe
Union

VÝSLEDKOVÁ LISTINA / RESULT LIST

Datum/date 29.7.93

C1M 500 m

Junioren

Opr.jízda/Repetage 3

Cas/Time 16:50

Závod
Race

36

		250 m	Total
1	CAN (5) 107 Buday Tamas	59.10 (1)	1:59.52
2	BUL (6) 89 Petrov Genaedi	1:00.14 (4) 01.04	2:00.01 00.49
3	ITA (4) 356 Bedin Andrea	59.26 (2) 00.16	2:01.60 02.08
4	MEX(2) 443 Castaneda Jose Luis	1:00.36 (5) 01.26	2:03.80 04.28
5	CZE (3) 142 Juttner Tomas	59.87 (3) 00.77	2:05.12 05.60
	LTU (7) 429 Paulauskas Dainius	Diskvalification	

1-3+the best 4th ->SF rest ->out

Temperatur: -water 21 °C -air 28 °C Wind: 0.5m/sec 150°

Chief Official: John Leukemans (BEL) Course Umpires: Amper D. (ISR) Bland P. (GBR)
Starters: Otto Tomiuc (ROM) Finish Line judge: Gunter Byhan (GER)



© Copyright Oliver Equipment

VÝSLEDKOVÁ LISTINA / RESULT LIST

Datum/date 29.7.93

K1W 500 m Junioren

Opr.jízda/Repetage 1

Cas/Time 17:00

Závod Race **37**

		250 m	Total
1	POL (6) 505 Slota Karolina	58.77 (1)	2:01.57
2	USA (3) 732 Beyer Tara	1:00.91 (3) 02.14	2:03.20 01.63
3	JPN (7) 373 Sayuri Maruyama	1:01.41 (4) 02.64	2:03.91 02.34
4	GBR (4) 245 Hemmings Anna	1:00.03 (2) 01.26	2:04.16 02.59
5	AUT (5) 31 Schlitzer Petra	1:02.01 (6) 03.24	2:10.67 09.10
6	NOR (8) 483 Halano May Lise	1:01.63 (5) 02.86	2:11.96 10.39
7	GRE (2) 291 Georgiadou Roza	1:06.68 (7) 07.91	2:16.98 15.41

1-3+the best 4th ->SF rest ->out

Temperatur: -water 21 °C -air 28 °C Wind: 1.1m/sec 160°

Chief Official: John Leukemans (BEL) Course Umpires: Janssens (BEL) Navasart (ROM)
Starters: Otto Tomiuc (ROM) Finish Line judge: Gunter Byhan (GER)



International
Canoe Federation

5th WORLD JUNIOR
CANOE
CHAMPIONSHIPS



29.7. - 1.8. 1993
RAČICE
CZECH REPUBLIC



Czech Canoe
Union

VÝSLEDKOVÁ LISTINA / RESULT LIST

Datum/date 29.7.93

K1W 500 m

Junioren

Závod
Race

38

Opr./šzda/Repetage 2

Cas/Time 17:11

		250 m	Total
1	SWE (5) 673 Karlsson Anna	58.39 (1)	2:00.53
2	MLD(6) 461 Nenno Anna	59.49 (3) 01.10	2:01.80 01.27
3	ARG (8) 1 Donadio Valeria	59.05 (2) 00.66	2:04.11 03.58
4	POR (7) 532 Silva Susana	1:00.53 (4) 02.14	2:05.19 04.66
5	FRA (2) 221 Agnes Isabelle	1:03.33 (5) 04.94	2:08.62 08.09
6	KOR (9) 392 Park Won Kyung	1:06.02 (7) 07.63	2:14.87 14.34
7	NED (3) 471 v.d. Endt Marion	1:04.65 (6) 06.26	2:16.55 16.02

1-3+the best 4th ->SF rest ->out

Temperatur: -water 21 °C -air 28.5°C Wind: 1.4m/sec 180°

Chief Official: John Leukemans (BEL)

Starters: Otto Tomiuc (ROM)

Course Umpires: Horvath (HUN) Chielewska (POL)

Finish Line judge: Gunter Byhan (GER)



COMPUTER SYSTEMS



© Olympic Athlete Equipment





International
Canoe Federation

5th WORLD JUNIOR
CANOE
CHAMPIONSHIPS



29.7. - 1.8. 1993
RACICE
CZECH REPUBLIC



Czech Canoe
Union

VÝSLEDKOVÁ LISTINA / RESULT LIST

Datum/date 29.7.93

K1W 500 m

Junioren

Opr./řzda/Repetage 3

Čas/Time 17:20

Závod
Race

39

		250 m	Total
1	HUN (6) 311 Bankuti Judit	58.93 (2) 00.27	1:59.16
2	ISR (4) 341 Carmi Lior	58.66 (1)	1:59.39 00.23
3	CAN (5) 103 Mckenzie Laura	1:00.36 (3) 01.70	2:03.12 03.96
4	AUS (7) 12 Nossiter Yanda	1:01.29 (4) 02.63	2:05.68 06.52
5	KAZ (2) 771 Loseva Olga	1:02.39 (5) 03.73	2:10.90 11.74
6	LTU (8) 421 Simonaviciute V.	1:03.43 (6) 04.77	2:13.91 14.75
7	EST (3) 211 Merila Age	1:06.35 (7) 07.69	2:19.21 20.05

1-3+the best 4th ->SF rest ->out

Temperatur: -water 21 °C -air 28.5°C Wind: 1.0m/sec 150°

Chief Official: John Leukemans (BEL) Course Umpires: Amper D. (ISR) Bland P. (GBR)
Starters: Otto Tomiuc (ROM) Finish Line judge: Gunter Byhan (GER)



COMPUTER SYSTEMS



© Copyright Office Equipment





International
Canoe Federation

5th WORLD JUNIOR
CANOE
CHAMPIONSHIPS



29.7. - 1.8. 1993
RAČICE
CZECH REPUBLIC



Czech Canoe
Union

VÝSLEDKOVÁ LISTINA / RESULT LIST

Datum/date 29.7.93

K2M 500 m

Junioren

Závod
Race **40**

Opr./řzda/Reptage 1

Cas/Time 17:34

			250 m	Total
1	RSA (7)	581 Caldwell Stuart 582 Du Toit Sakkie	48.12 (1)	1:39.03
2	UKR (6)	716 Tchernenko Serguei 713 Navitnyi Oleg	48.34 (2) 00.22	1:39.98 00.95
3	POR (5)	539 Varela Sergio 533 Almeida Carlos	49.05 (3) 00.93	1:40.95 01.92
4	CAN (3)	116 Smith Dave 109 Illsley Scott	49.38 (4) 01.26	1:41.40 02.37
5	MEX (4)	446 Heinze Ralph 444 Dominguez Emilio	50.65 (5) 02.53	1:43.09 04.06
6	JPN (8)	385 Yasuo Miyake 378 Kazunori Tagami	50.98 (6) 02.86	1:44.05 05.02
7	SLO (1)	626 Dodic Mitja 628 Planinc Marjan	58.39 (7) 10.27	2:02.62 23.59

1-4 ->SF rest ->out

Temperatur: -water 21 °C -air 27 °C Wind: 1.4m/sec 160°

Chief Official: John Leukemans (BEL) Course Umpires: Janssens (BEL) Navasart (ROM)
Starters: Otto Tomiuc (ROM) Finish Line judge: Gunter Byhan (GER)

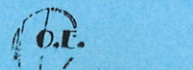



International
Canoe Federation

5th WORLD JUNIOR
CANOE
CHAMPIONSHIPS



29.7. - 1.8. 1993
RAČICE
CZECH REPUBLIC



Czech Canoe
Union

VÝSLEDKOVÁ LISTINA / RESULT LIST

Datum/date 29.7.93

K2M 500 m

Junioren

Opr./řzda/Repetage 2

Cas/Time 17:40

Závod
Race

41

		250 m	Total
1	POL (6) 507 Aleksandrowicz W. 511 Markiewicz Jaroslaw	48.78 (1)	1:41.31
2	AUT (5) 32 Hinterhofer Martin 33 Stollnberger Markus	50.53 (5) 01.75	1:41.77 00.46
3	TKM (3) 693 Chevtchouk Alexandre 692 Provotorov Dmitri	50.31 (4) 01.53	1:41.90 00.59
4	USA (7) 738 Mowat Kai 736 Farnum Jim	49.05 (2) 00.27	1:42.12 00.81
5	KAZ (4) 776 Egorov Evgenij 777 Sobcinskij Dimitrij	49.76 (3) 00.98	1:42.39 01.08
6	EST (8) 216 Vello Raul 214 Lelov Toomas	51.80 (7) 03.02	1:46.78 05.47
7	BRA (1) 72 Lozz Ricardo 73 Mattiello Bruno Lebr.	51.36 (6) 02.58	1:47.25 05.94
8	ARG (2) 7 Suaya Pablo 3 Basualto Ariel	52.35 (8) 03.57	1:53.08 11.77

1-4 ->SF rest ->out

Temperatur: -water 21 °C -air 27 °C Wind: 0.7m/sec 180°

Chief Official: John Leukemans (BEL)

Course Umpires: Horvath (HUN) Chielewska (POL)

Starters: Otto Tomiuc (ROM)

Finish Line judge: Gunter Byhan (GER)



COMPUTER SYSTEMS





International
Canoe Federation

5th WORLD JUNIOR
CANOE
CHAMPIONSHIPS



29.7. - 1.8. 1993
RAČICE
CZECH REPUBLIC



Czech Canoe
Union

VÝSLEDKOVÁ LISTINA / RESULT LIST

Datum/date 29.7.93

K2M 500 m

Junioren

Opr.jízda/Repetage 3

Čas/Time 17:50

Závod
Race **42**

		250 m	Total
1	ROM(5) 571 Sirbu Marian 562 Condache Mihail	46.68 (1)	1:36.60
2	SUI (8) 662 Rohr Mathias 661 Bachmann Adrian	49.10 (2) 02.42	1:41.10 04.50
3	NOR (6) 487 Gjeroe Andreas 488 Rudolfsen Frooe	49.37 (3) 02.69	1:42.34 05.74
4	KOR (7) 394 Kim Yong Kyo 395 Lee Kyung Soo	49.87 (4) 03.19	1:42.70 06.10
5	AUS (4) 22 Prosser Greg 16 Chilvers Mike	50.24 (5) 03.56	1:42.84 06.24
6	GBR (3) 257 Smith David 251 Hemmings Brian	52.67 (7) 05.99	1:45.34 08.74
7	MLD(9) 463 Vitt Igori 462 Babitch Jeuri	50.64 (6) 03.96	1:46.32 09.72

1-4 ->SF rest ->out

Temperatur: -water 21 °C -air 27 °C Wind: 0.6m/sec 160°

Chief Official: John Leukemans (BEL) Course Umpires: Amper D. (ISR) Bland P. (GBR)
Starters: Otto Tomiuc (ROM) Finish Line judge: Gunter Byhan (GER)



COMPUTER SYSTEMS





International
Canoe Federation

5th WORLD JUNIOR
CANOE
CHAMPIONSHIPS



29.7. - 1.8. 1993
RAČICE
CZECH REPUBLIC



Czech Canoe
Union

VÝSLEDKOVÁ LISTINA / RESULT LIST

Datum/date 29.7.93

C2M 500 m

Junioren

Opr./řzda/Repetage 1

Cas/Time 18:00

Závod
Race **43**

		250 m	Total
1	POL (4) 512 Midloch Pawel 513 Midloch Piotr	56.85 (1)	1:56.45
2	GBR (6) 248 Crowther Stuart 253 Lane Malcolm	57.78 (3) 00.93	1:56.82 00.37
3	CZE (5) 156 Sterba Petr 147 Kozelsky David	57.29 (2) 00.44	1:57.20 00.75
4	POR (7) 535 Oliveira Rui 536 Reis Helio	59.54 (4) 02.69	2:00.52 04.07
5	EST (3) 215 Rumm Ranno 212 Hollo Mihkel	1:00.36 (5) 03.51	2:03.81 07.36

1-4+the best 5th ->SF

Temperatur: -water 21 °C -air 27 °C Wind: 0.0m/sec

Chief Official: John Leukemans (BEL) Course Umpires: Janssens (BEL) Navasart (ROM)
Starters: Otto Tomiuc (ROM) Finish Line judge: Gunter Byhan (GER)



COMPUTER SYSTEMS



Complete Office Equipment





International
Canoe Federation

5th WORLD JUNIOR
CANOE
CHAMPIONSHIPS



29.7. - 1.8. 1993
RAČICE
CZECH REPUBLIC



Czech Canoe
Union

VÝSLEDKOVÁ LISTINA / RESULT LIST

Datum/date 29.7.93

C2M 500 m

Junioren

Závod
Race

44

Opr.jízda/Repetage

2

Cas/Time 18:10

		250 m	Total
1	FRA (4) 233 Moreaux Denis 234 Normand Samuel	57.23 (1)	1:56.53
2	MEX (5) 443 Castaneda Jose Luis 442 Castaneda Benjamin	57.83 (2) 00.60	1:57.56 01.03
3	LTU (6) 430 Polomosnov Andrej 427 Medvedev Konstantin	58.77 (3) 01.54	1:59.38 02.85
4	USA (3) 737 Johnson Nate 735 Batlik Vaclav	1:00.30 (5) 03.07	2:01.60 05.07
5	JPN (7) 375 Eiji Uejyo 386 Yoshimi Hosotani	59.81 (4) 02.58	2:02.85 06.32

1-4+the best 5th ->SF

Temperatur: -water 21 °C -air 27 °C Wind: 0.0m/sec

Chief Official: John Leukemans (BEL) Course Umpires: Horvath (HUN) Chielewska (POL)
Starters: Otto Tomiuc (ROM) Finish Line judge: Gunter Byhan (GER)



COMPUTER SYSTEMS

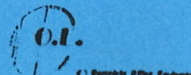



International
Canoe Federation

5th WORLD JUNIOR
CANOE
CHAMPIONSHIPS



29.7. - 1.8. 1993
RAČICE
CZECH REPUBLIC



VÝSLEDKOVÁ LISTINA / RESULT LIST

Datum/date 29.7.93

K2W 500 m

Junioren

Opr./řzda/Repetage 1

Cas/Time 18:20

Závod
Race **45**

		250 m	Total
1	ROM (5) 553 Ionita Racula 555 Pirvu Carmen	54.05 (2) 00.22	1:51.92
2	SVK (3) 642 Hochschornerova Eva 641 Birvonova Miriam	53.83 (1)	1:52.60 00.68
3	NOR (8) 483 Halano May Lise 484 Knuosen Christine	56.08 (3) 02.25	1:55.86 03.94
4	USA (6) 732 Beyer Tara 734 White Olivia	57.73 (4) 03.90	1:56.07 04.15
5	ARG (2) 2 Maino Andrea 1 Donadio Valeria	58.44 (6) 04.61	1:59.08 07.16
6	KOR (7) 392 Park Won Kyung 391 Ji Mi Jun	1:01.19 (7) 07.36	1:59.69 07.77
7	POR (4) 532 Silva Susana 531 Azevedo Julieta	58.00 (5) 04.17	2:00.17 08.25
8	GRE (1) 291 Georgiadou Roza 293 Tsiupi Hrisula	1:05.64 (8) 11.81	2:14.08 22.16
9	SLO (9) 623 Kozel Lea 621 Bratasevec Tina	1:09.10 (9) 15.27	2:22.22 30.30

1-4+the best 5th ->SF rest ->out

Temperatur: -water 21 °C -air 27 °C Wind: 0.0m/sec

Chief Official: John Leukemans (BEL) Course Umpires: Amper D. (ISR) Bland P. (GBR)
Starters: Otto Tomiuc (ROM) Finish Line judge: Gunter Byhan (GER)



COMPUTER SYSTEMS



Complete Office Equipment





International
Canoe Federation

5th WORLD JUNIOR
CANOE
CHAMPIONSHIPS



29.7. - 1.8. 1993
RAČICE
CZECH REPUBLIC



Czech Canoe
Union

VÝSLEDKOVÁ LISTINA / RESULT LIST

Datum/date 29.7.93

K2W 500 m

Junioren

Opr./řzda/Repetage 2

Cas/Time 18:30

Závod
Race

46

			250 m	Total
1	ESP (6)	193 Iglesias Andrea 195 Romero Antonia	53.28 (1)	1:51.53
2	ITA (7)	351 Pedrazzi Silvia 352 Pellegrini Ilenia	57.90 (6) 04.62	1:55.11 03.58
3	GBR (2)	242 Fowler Suzanne 243 Giles Rebecca	55.34 (2) 02.06	1:55.12 03.59
4	KAZ (4)	772 Parfjonova Elena 773 Muravjova Natalja	55.87 (3) 02.59	1:55.19 03.66
5	FRA (5)	223 Clet Cecile 226 Metenier Linda	56.74 (4) 03.46	1:56.23 04.70
6	JPN (9)	374 Yoshika Oonishi 372 Sanae Nakao	57.34 (5) 04.06	1:58.10 06.57
7	AUS (3)	12 Nossiter Yanda 11 Marot Christy	58.27 (7) 04.99	2:01.52 09.99
8	NED (1)	472 Ham Pauline 473 Leeman Minouk	59.15 (8) 05.87	2:10.34 18.81

1-4+the best 5th ->SF rest ->out

Temperatur: -water 21 °C -air 26 °C Wind: 0.0m/sec

Chief Official: John Leukemans (BEL) Course Umpires: Janssens (BEL) Navasart (ROM)
Starters: Otto Tomiuc (ROM) Finish Line judge: Gunter Byhan (GER)



© Complete Other Equipment



VÝSLEDKOVÁ LISTINA / RESULT LIST

Datum/date 29.7.93

K4M 500 m		Junioren		Závod / Race	
Opr. jízda/Repetage 1		Cas/Time 18:42		47	
		250 m	Total		
1	CZE (5)	153 Sarka Jan 141 Hejda Premysl 157 Termer Vlastimil 158 Tonder Tomas	44.11 (1)	1:29.58	
2	ITA (6)	357 Blasi Andrea 366 Favalli Simone 368 Nardelli Ciro 363 Mate Davide.	44.44 (2) 00.33	1:31.29 01.71	
3	NOR (3)	489 Sigurosen Stian 486 Fjeloheim Nils Olav 487 Gjeroe Andreas 488 Rudolfsen Frooe	44.82 (3) 00.71	1:31.96 02.38	
4	CAN (8)	112 Maksymiuk Daniel 108 Cobb Graham 116 Smith Dave 109 Illsley Scott	45.70 (4) 01.59	1:33.19 03.61	
5	LAT (4)	411 Petersons Gundars 405 Berzins Kaspars 412 Zalupe Kristaps 407 Greizis Ugis	46.20 (5) 02.09	1:34.66 05.08	
6	KOR (2)	398 Nam Sung Ho 394 Kim Yong Kyo 397 Moon Chul Wook 395 Lee Kyung Soo	46.64 (6) 02.53	1:37.09 07.51	
7	MEX (7)	448 Revuelta Raul 449 Sierra Luis 447 Heredia Rafael 444 Dominguez Emilio	48.78 (7) 04.67	1:40.04 10.46	

1-3+the best 4th ->SF rest ->out

Temperatur: -water 21 °C -air 26 °C Wind: 0.0m/sec

Chief Official: John Leukemans (BEL) Course Umpires: Horvath (HUN) Chielewska (POL)
Starters: Otto Tomiuc (ROM) Finish Line judge: Gunter Byhan (GER)

VÝSLEDKOVÁ LISTINA / RESULT LIST

Datum/date 29.7.93

K4M 500 m		Junioren	Závod Race	
Opr.jízda/Repetage	2	Cas/Time	18:52	48
		250 m	Total	
1	SVK (4)	649 Kasuba Lucian 647 Brodsky Ladislav 650 Kiss Roman 656 Straka Peter	44.32 (1)	1:30.41
2	SWE (5)	682 Nilsson Henrik 681 Myrman Royne 680 Haglund Hans 678 Berglund Mats	44.60 (2) 00.28	1:30.56 00.15
3	ROM(6)	558 Andrei Mihaita 560 Baban Marian 564 Enache Mihail 567 Hanches Ioan	44.98 (3) 00.66	1:31.65 01.24
4	FIN (8)	792 Keso Mikko 793 Ruokonen Riku 794 Winquist Simon 795 Mikkonen Kalle	45.75 (4) 01.43	1:32.28 01.87
5	NED (2)	478 Visser Gido 475 de Rooy Maurits 476 Kossen Wouter 477 v.d. Pol Tobias	46.79 (5) 02.47	1:36.23 05.82
6	USA (3)	736 Farnum Jim 738 Mowat Kai 741 Watanabe Chuck 739 Osusky Juraj	48.88 (7) 04.56	1:37.41 07.00
7	GBR (7)	256 Sargeant Ian 249 Darby Dowman Paul 257 Smith David 251 Hemmings Brian	48.44 (6) 04.12	1:38.68 08.27
8	GRE (1)	301 Sideropulos Panaiotis 299 Montanaris Stelios 302 Skouliariotis Georgos 300 Rountos Iorgos	51.19 (8) 06.87	1:46.10 15.69
9	SLO (9)	627 Jakomin Dejan 626 Dodic Mitja 628 Planinc Marjan 629 Rener Marko	55.36 (9) 11.04	1:54.13 23.72

1-3+the best 4th ->SF rest ->out

Temperatur: -water 21 °C -air 26 °C Wind: . 0.0m/sec

Chief Official: John Leukemans (BEL) Course Umpires: Amper D. (ISR) Bland P. (GBR)
Starters: Otto Tomiuc (ROM) Finish Line judge: Gunter Byhan (GER)



International
Canoe Federation

5th WORLD JUNIOR
CANOE
CHAMPIONSHIPS



29.7. - 1.8. 1993
RAČICE
CZECH REPUBLIC



VÝSLEDKOVÁ LISTINA / RESULT LIST

Datum/date 29.7.93

K4M 500 m

Junioren

Opr./řzda/Repechage 3

Čas/Time 19:02

Závod
Race

49

		250 m	Total
1	ARG (8) 7 Suaya Pablo 3 Basualto Ariel 4 Canepa Diego 5 Correa Javier	45.64 (3) 00.98	1:31.79
2	POR (4) 539 Varela Sergio 534 Fazenda Diogo 538 Sousa Jose 533 Almeida Carlos	45.32 (2) 00.66	1:32.35 00.56
3	DEN (6) 172 Eilert Michael 177 Rasmussen Brian 179 Svenningen Claus 174 Heering Nicolai	47.07 (6) 02.41	1:32.40 00.61
4	UKR (1) 715 Sivko Alexandr 707 Berzin Serguei 711 Kutcherenko Serguei 713 Navitnyi Oleg	44.66 (1)	1:33.10 01.31
5	AUS (5) 14 Beresford-Peir Digby 19 Curry Billy 17 Clayton James 18 Croker Glen	48.72 (7) 04.06	1:34.85 03.06
6	LTU (7) 424 Gerulskis Edmundas 422 Balciunas Egidijus 431 Varnas Tomas 428 Mironeko Ruslan	45.76 (4) 01.10	1:35.03 03.24
7	BEL (3) 44 Noppe Tom 42 Deslee Henk 43 Maesen Bob 48 Vandenbruwaene Leslie	46.03 (5) 01.37	1:35.19 03.40
8	JPN (2) 385 Yasuo Miyake 378 Kazunori Tagami 376 Hiroaki Matsumoto 384 Takaichi Nakatsu	52.07 (8) 07.41	1:46.52 14.73

1-3+the best 4th ->SF rest ->out

Temperatur: -water 21 °C -air 26 °C Wind: 0.0m/sec

Chief Official: John Leukemans (BEL) Course Umpires: Janssens (BEL) Navasart (ROM)
Starters: Otto Tomiuc (ROM) Finish Line judge: Gunter Byhan (GER)



COMPUTER SYSTEMS



Complete Office Equipment



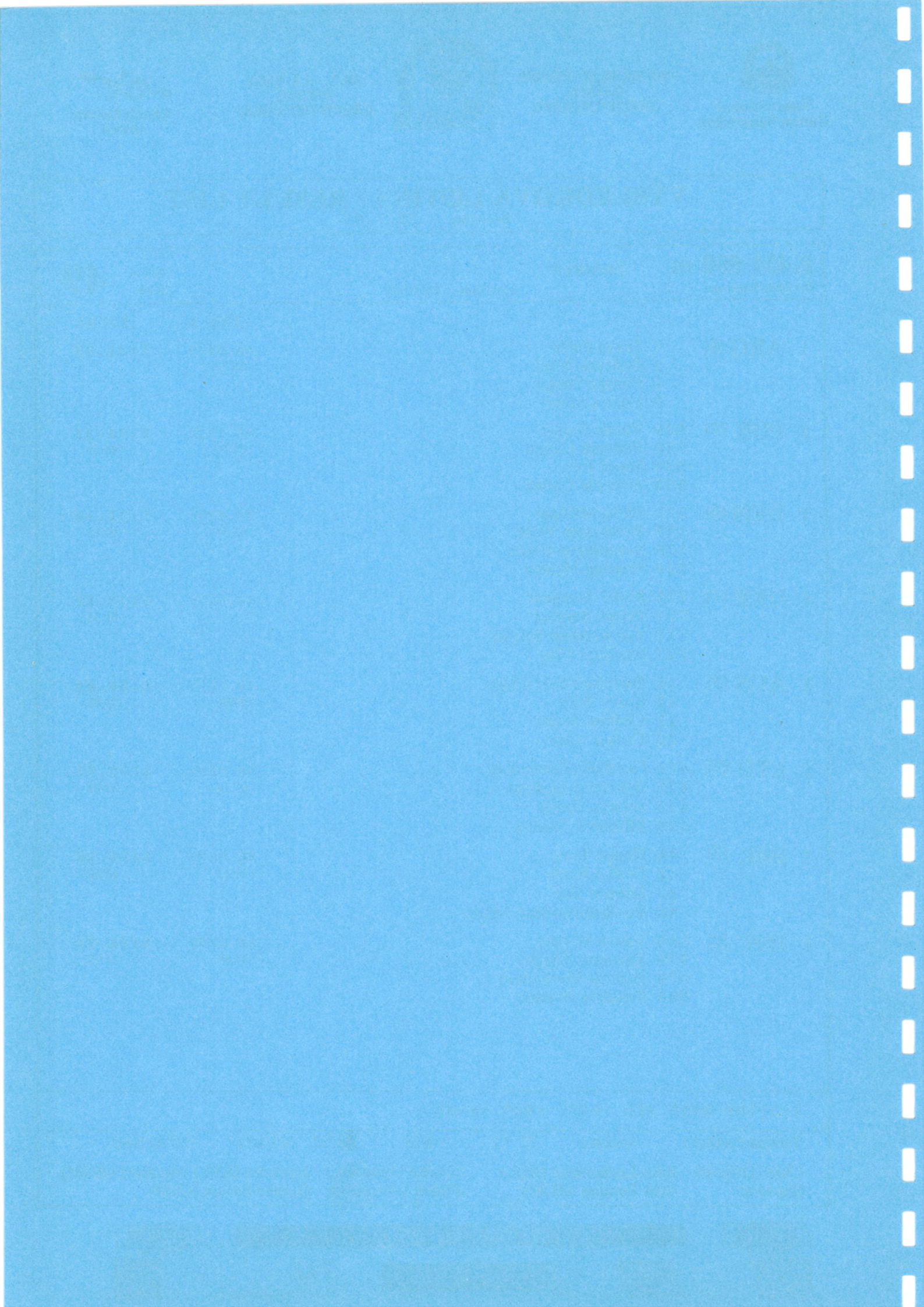

VÝSLEDKOVÁ LISTINA / RESULT LIST

Datum/date 30.7.93

K1M 1000 m Junioren

Závod
Race **50**

Rozjízdky/Heat

1

Cns/Time 08:34

			250 m	500 m	750 m	Total
1	GER (3)	279 Ulm Stefan	55.53 (1)	1:55.02 (1)	2:53.29 (1)	3:51.95
2	FRA (7)	231 Huguet Cyril	56.68 (4) 01.15	1:56.39 (2) 01.37	2:54.66 (2) 01.37	3:54.57 02.62
3	DEN (8)	174 Heering Nicolai	56.14 (2) 00.61	1:57.43 (3) 02.41	2:56.20 (3) 02.91	3:56.44 04.49
4	LAT (4)	411 Petersons Gundars	57.84 (6) 02.31	1:59.96 (7) 04.94	3:00.27 (6) 06.98	4:00.95 09.00
5	SVK (2)	651 Kuzel Rastislav	58.55 (8) 03.02	1:58.97 (5) 03.95	2:57.36 (4) 04.07	4:02.02 10.07
6	SUI (5)	661 Bachmann Adrian	56.47 (3) 00.94	1:58.64 (4) 03.62	2:59.94 (5) 06.65	4:03.05 11.10
7	RSA (1)	581 Caldwell Stuart	58.22 (7) 02.69	1:59.52 (6) 04.50	3:02.79 (7) 09.50	4:07.64 15.69
8	NED (9)	477 v.d. Pol Tobias	57.18 (5) 01.65	2:00.17 (8) 05.15	3:03.95 (8) 10.66	4:11.08 19.13
9	FIN (6)	791 Latvamaki Kimmo	1:00.31 (9) 04.78	2:07.04 (9) 12.02	3:14.49 (9) 21.20	4:21.84 29.89

1-2 ->SF rest ->R

Temperatur: -water 20 °C -air 20 °C Wind: 0.4m/sec 100°

Chief Official: John Leukemans (BEL)
Starters: Mike Moir (CAN)

Course Umpires: Horvath (HUN) Chielewska (POL)
Finish Line judge: Gunter Byhan (GER)

VÝSLEDKOVÁ LISTINA / RESULT LIST

Datum/date 30.7.93

K1M 1000 m Junioren

Rozjízdky/Hent

2

Čas/Time 08:40

Závod
Rnce

51

			250 m	500 m	750 m	Total
1	HUN (3)	320 Bauer Marton	56.30 (2) 02.31	1:51.44 (2) 00.88	2:50.27 (1)	3:48.75
2	AUS (5)	20 Evans Peter	53.99 (1)	1:50.56 (1)	2:50.65 (2) 00.38	3:49.02 00.27
3	UKR (9)	711 Kutcherenko Serguei	58.00 (3) 04.01	1:52.70 (3) 02.14	2:51.42 (3) 01.15	3:50.87 02.12
4	BEL (4)	47 Stevens David	58.49 (4) 04.50	1:54.90 (4) 04.34	2:54.77 (4) 04.50	3:55.10 06.35
5	MEX (7)	446 Heinze Ralph	1:01.52 (8) 07.53	2:01.44 (7) 10.88	3:03.06 (5) 12.79	4:05.44 16.69
6	ISR (8)	342 Hardoof Ronen	1:00.94 (7) 06.95	2:00.06 (5) 09.50	3:04.00 (6) 13.73	4:09.40 20.65
7	GBR (1)	256 Sargeant Ian	59.37 (5) 05.38	2:00.61 (6) 10.05	3:06.14 (7) 15.87	4:11.61 22.86
8	EST (2)	216 Vello Raul	1:00.69 (6) 06.70	2:02.15 (8) 11.59	3:12.18 (8) 21.91	4:23.00 34.25

1-2 ->SF rest ->R

Temperatur: -water 20 °C -air 20 °C Wind: 0.0m/sec

Chief Official: John Leukemans (BEL) Course Umpires: Amper D. (ISR) Bland P. (GBR)
Starters: Mike Moir (CAN) Finish Line judge: Gunter Byhan (GER)

VÝSLEDKOVÁ LISTINA / RESULT LIST

Datum/date 30.7.93

K1M 1000 m Junioren

Rozjřzdzka/Heat

3

Cas/Time 08:50

Závod

Race **52**

			250 m	500 m	750 m	Total
1	ITA (4)	361 Majocchi Jacopo	55.47 (2) 00.38	1:54.24 (1)	2:54.11 (1)	3:54.09
2	CAN (5)	112 Maksymiuk Daniel	57.67 (5) 02.58	1:57.10 (4) 02.86	2:56.75 (3) 02.64	3:56.51 02.42
3	RUS (6)	612 Tissin Andrei	55.09 (1)	1:54.68 (2) 00.44	2:56.48 (2) 02.37	3:58.16 04.07
4	POR (3)	533 Almeida Carlos	57.01 (4) 01.92	1:56.50 (3) 02.26	2:59.11 (4) 05.00	4:02.55 08.46
5	USA (2)	739 Osusky Juraj	58.61 (7) 03.52	1:59.30 (5) 05.06	3:02.52 (5) 08.41	4:02.88 08.79
6	BRA (7)	71 Lopes Denis Ferre	58.11 (6) 03.02	2:00.67 (7) 06.43	3:03.29 (6) 09.18	4:04.25 10.16
7	LTU (8)	431 Varnas Tomas	59.65 (9) 04.56	2:04.85 (8) 10.61	3:09.82 (8) 15.71	4:12.88 18.79
8	MLD(1)	463 Vitt Igori	56.79 (3) 01.70	2:00.07 (6) 05.83	3:05.65 (7) 11.54	4:13.37 19.28
9	GRE (9)	299 Montanaris Stelios	59.21 (8) 04.12	2:05.94 (9) 11.70	3:14.88 (9) 20.77	4:22.93 28.84

1-2 ->SF rest ->R

Temperatur: -water 20 °C -air 20 °C Wind: 0.0m/sec

Chief Official: John Leukemans (BEL)

Course Umpires: Janssens (BEL) Navasart (ROM)

Starters: Mike Moir (CAN)

Finish Line judge: Gunter Byhan (GER)



International
Canoe Federation

5th WORLD JUNIOR
CANOE
CHAMPIONSHIPS



29.7. - 1.8. 1993
RAČICE
CZECH REPUBLIC



VÝSLEDKOVÁ LISTINA / RESULT LIST

Datum/date 30.7.93

K1M 1000 m Junioři

Rozjízdky/Heat 4

Cas/Time 08:59

Závod
Race **53**

			250 m	500 m	750 m	Total
1	BLR (2) 56	Borisik Piotr	53.22 (1)	1:52.49 (1)	2:50.65 (1)	3:51.18
2	ESP (3) 198	Cuinas Antonio	56.25 (3) 03.03	1:55.40 (3) 02.91	2:52.85 (2) 02.20	3:53.71 02.53
3	SWE (1) 682	Nilsson Henrik	55.42 (2) 02.20	1:55.02 (2) 02.53	2:55.65 (4) 05.00	3:56.40 05.22
4	POL (8) 509	Lakomy Pawel	57.01 (4) 03.79	1:56.94 (4) 04.45	2:55.38 (3) 04.73	3:59.26 08.08
5	CZE (5) 140	Dvorak Martin	59.82 (7) 06.60	2:01.88 (6) 09.39	3:03.95 (6) 13.30	4:07.61 16.43
6	TKM (7) 693	Chevtchouk Alexandre	57.89 (5) 04.67	2:01.39 (5) 08.90	3:03.62 (5) 12.97	4:09.09 17.91
7	JPN (6) 379	Kazutoshi Mishima	58.94 (6) 05.72	2:03.09 (7) 10.60	3:08.67 (7) 18.02	4:14.03 22.85
8	KOR (4) 395	Lee Kyung Soo	1:00.31 (8) 07.09	2:06.06 (8) 13.57	3:11.20 (8) 20.55	4:14.53 23.35

1-2 ->SF rest ->R

Temperatur: -water 20 °C -air 20 °C Wind: 0.5m/sec 50°

Chief Official: John Leukemans (BEL) Course Umpires: Horvath (HUN) Chielewska (POL)
Starters: Mike Moir (CAN) Finish Line judge: Gunter Byhan (GER)



Computer Office Equipment



VÝSLEDKOVÁ LISTINA / RESULT LIST

Datum/date 30.7.93

C1M 1000 m Junioren

Rozjízdky/Heat

1

Can/Time 09:10

Závod
Race

54

			250 m	500 m	750 m	Total
1	HUN (7)	319 Balgovits Gabor	1:05.09 (2) 01.70	2:14.18 (2) 01.75	3:19.99 (1)	4:26.84
2	POL (1)	508 Kondracki Edward	1:06.63 (5) 03.24	2:15.94 (5) 03.51	3:23.45 (4) 03.46	4:28.12 01.28
3	LAT (4)	408 Klava Ainars	1:03.39 (1)	2:12.43 (1)	3:21.30 (2) 01.31	4:28.45 01.61
4	SVK (6)	654 Pales Andrej	1:05.86 (3) 02.47	2:14.57 (3) 02.14	3:22.57 (3) 02.58	4:29.03 02.19
5	MEX (8)	443 Castaneda Jose Luis	1:06.90 (6) 03.51	2:16.93 (6) 04.50	3:28.17 (6) 08.18	4:36.42 09.58
6	RUS (5)	607 Lantsayev Vasilij	1:06.19 (4) 02.80	2:15.50 (4) 03.07	3:24.65 (5) 04.66	4:36.80 09.96
7	GBR (2)	254 Love Jonathan	1:07.40 (7) 04.01	2:18.08 (7) 05.65	3:28.50 (7) 08.51	4:38.75 11.91
8	KAZ (9)	778 Kirnenko Sergej	1:08.22 (8) 04.83	2:22.09 (8) 09.66	3:38.50 (8) 18.51	4:56.40 29.56
9	SLO (3)	627 Jakomin Dejan	1:19.70 (9) 16.31	2:45.22 (9) 32.79	4:08.59 (9) 48.60	5:31.48 1:04.64

1-3 ->SF rest ->R

Temperatur: -water 20 °C -air 21 °C Wind: 1.6m/sec 30°

Chief Official: John Leukemans (BEL)

Course Umpires: Amper D. (ISR) Bland P. (GBR)

Starters: Mike Moir (CAN)

Finish Line judge: Gunter Byhan (GER)



International
Canoe Federation

5th WORLD JUNIOR
CANOE
CHAMPIONSHIPS



29.7. - 1.8. 1993
RAČICE
CZECH REPUBLIC



VÝSLEDKOVÁ LISTINA / RESULT LIST

Datum/date 30.7.93

C1M 1000 m Junioren

Rozjízdká/Heat 2

Cas/Time 09:20

Závod
Race **55**

			250 m	500 m	750 m	Total
1	ROM(9) 568	Huidu Florian	1:02.23 (1)	2:07.10 (1)	3:14.32 (1)	4:22.40
2	CRO (6) 123	Funtak Drazen	1:03.16 (3) 00.93	2:09.62 (2) 02.52	3:16.52 (2) 02.20	4:23.68 01.28
3	CAN (4) 107	Buday Tamas	1:03.93 (4) 01.70	2:10.89 (4) 03.79	3:18.39 (3) 04.07	4:28.05 05.65
4	ITA (7) 356	Bedin Andrea	1:04.98 (6) 02.75	2:13.03 (5) 05.93	3:22.40 (5) 08.08	4:28.69 06.29
5	BLR (3) 66	Zhookevskij Dmitrij	1:02.83 (2) 00.60	2:10.56 (3) 03.46	3:21.90 (4) 07.58	4:33.91 11.51
6	LTU (5) 429	Paulauskas Dainius	1:04.43 (5) 02.20	2:16.10 (7) 09.00	3:31.02 (7) 16.70	4:39.12 16.72
7	FRA (2) 230	Ethuin David	1:06.07 (7) 03.84	2:15.72 (6) 08.62	3:27.34 (6) 13.02	4:39.48 17.08
8	JPN (8) 383	Shigeo Tanaka	1:07.94 (8) 05.71	2:21.54 (8) 14.44	3:32.94 (8) 18.62	4:47.17 24.77
9	POR (1) 536	Reis Helio	1:08.60 (9) 06.37	2:23.79 (9) 16.69	3:36.62 (9) 22.30	4:52.80 30.40

1-3 ->SF rest ->R

Temperatur: -water 20 °C -air 21 °C Wind: 0.5m/sec 30°

Chief Official: John Leukemans (BEL) Course Umpires: Janssens (BEL) Navasart (ROM)
Starters: Mike Moir (CAN) Finish Line judge: Gunter Byhan (GER)



COMPUTER SYSTEMS





International
Canoe Federation

5th WORLD JUNIOR
CANOE
CHAMPIONSHIPS



29.7. - 1.8. 1993
RAČICE
CZECH REPUBLIC



Czech Canoe
Union

VÝSLEDKOVÁ LISTINA / RESULT LIST

Datum/date 30.7.93

C1M 1000 m Juniores

Rozjízdky/Heat 3

Cas/Time 09:30

Závod
Race **56**

			250 m	500 m	750 m	Total	
1	GER (5)	266	Bebber Ricardo	1:00.09 (1)	2:06.82 (2) 00.77	3:13.06 (2) 00.49	4:19.74
2	ESP (6)	203	Mascato David	1:00.25 (2) 00.16	2:06.05 (1)	3:12.57 (1)	4:20.97 01.23
3	CZE (8)	137	Brecka Jan	1:02.94 (5) 02.85	2:10.01 (3) 03.96	3:17.02 (4) 04.45	4:22.53 02.79
4	DEN (7)	178	Scales Carsten	1:03.16 (6) 03.07	2:10.61 (5) 04.56	3:16.03 (3) 03.46	4:22.91 03.17
5	UKR (1)	708	Dvoulyat Serguei	1:01.74 (3) 01.65	2:10.34 (4) 04.29	3:22.95 (5) 10.38	4:33.32 13.58
6	KOR (2)	396	Lee Seoung Woo	1:03.55 (7) 03.46	2:11.33 (6) 05.28	3:24.15 (6) 11.58	4:36.58 16.84
7	GRE (3)	294	Arapis Athanasios	1:02.23 (4) 02.14	2:13.41 (7) 07.36	3:24.71 (7) 12.14	4:38.02 18.28
8	EST (4)	213	Koiva Kaspar	1:07.83 (8) 07.74	2:21.49 (8) 15.44	3:37.01 (8) 24.44	4:56.80 37.06

1-3 ->SF rest ->R

Temperatur: -water 20 °C -air 21 °C Wind: 0.3m/sec 60°

Chief Official: John Leukemans (BEL) Course Umpires: Horvath (HUN) Chielewska (POL)
Starters: Mike Moir (CAN) Finish Line judge: Gunter Byhan (GER)



© Copyright Oliver Schönbauer



VÝSLEDKOVÁ LISTINA / RESULT LIST

Datum/date 30.7.1993

Závod
Race **57**

NO RACE



International
Canoe Federation

5th WORLD JUNIOR
CANOE
CHAMPIONSHIPS



29.7. - 1.8. 1993
RACICE
CZECH REPUBLIC



VÝSLEDKOVÁ LISTINA / RESULT LIST

Datum/date 30.7.93

K4W 500 m Junioren

Rozjízdky/Heat 1

Cas/Time 09:50

Závod
Race **58**

			250 m	Total
1	GER (5)	262 Mucke Manuela 263 Muller Heike 264 Opgen-Rhein Nadine 265 Wagner Katrin	50.70 (1)	1:42.90
2	GBR (6)	245 Hemmings Anna 242 Fowler Suzanne 243 Giles Rebecca 246 Ormerod Emily	53.22 (4) 02.52	1:44.90 02.00
3	ITA (4)	352 Pellegrini Ilenia 351 Pedrazzi Silvia 353 Ricciotti Anne Odette 354 Silvestri Sara	52.79 (3) 02.09	1:45.05 02.15
4	RUS (1)	595 Tishyenko Tatyana 591 Anikeyeva Yuliya 593 Minayeva Marina 592 Kononova Yuliya	52.35 (2) 01.65	1:45.61 02.71
5	CAN (2)	102 Giles Kristina 103 Mckenzie Laura 105 Prince Karina 101 Furneaux Karen	53.88 (5) 03.18	1:48.33 05.43
6	NOR (3)	483 Halano May Lise 484 Knuosen Christine 482 Fjeloheim Marianne 481 Berntsen Anne Grete	54.16 (6) 03.46	1:50.00 07.10
7	SLO (7)	624 Labignan Sandra 622 Culibrk Dunja 625 Strupar Zaneta 623 Kozel Lea	1:07.07 (7) 16.37	2:15.26 32.36

1-3 ->SF rest ->R

Temperatur: -water 20 °C -air 22 °C Wind: 0.0m/sec

Chief Official: John Leukemans (BEL) Course Umpires: Janssens (BEL) Navasart (ROM)
Starters: Otto Tomiuc (ROM) Finish Line judge: Gunter Byhan (GER)



COMPUTER SYSTEMS

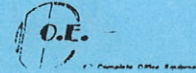

VÝSLEDKOVÁ LISTINA / RESULT LIST

Datum/date 30.7.93

K4W 500 m

Junioren

Závod
Race

59

Rozjízdky/Heat

2

Cas/Time 10:00

		250 m	Total
1	HUN (3)	50.26 (2) 00.44	1:42.11
	311 Bankuti Judit		
	314 Kovacs Katalin		
	312 Barocsi Andrea		
	315 Luchterhand Larissza		
2	ROM (6)	49.82 (1)	1:43.30 01.19
	553 Ionita Racula		
	552 Cristoa Mirola		
	556 Radu Blena		
	555 Pirvu Carmen		
3	POL (4)	50.64 (3) 00.82	1:43.65 01.54
	505 Slota Karolina		
	504 Pastuszka Aneta		
	503 Opara Monika		
	501 Gregorowicz Kinga		
4	CZE (5)	52.12 (6) 02.30	1:43.73 01.62
	134 Hlucha Katerina		
	131 Borkovcova Sarka		
	133 Hekova Katerina		
	136 Pergnerova Milena		
5	BLR (1)	51.13 (4) 01.31	1:44.24 02.13
	51 Bet Elena		
	52 Maslova Natalia		
	54 Subotenko Olga		
	53 Pajgraj Nadezhda		
6	UKR (2)	51.63 (5) 01.81	1:44.59 02.48
	702 Kovalenko Anna		
	703 Litchman Tatiana		
	705 Yurtchenko Ekaterina		
	704 Tchaytchouk Alevtina		
7	SWE (7)	52.62 (7) 02.80	1:47.48 05.37
	674 Karlsson Therese		
	671 Augustsson Lisen		
	672 Hamrin Jenny		
	675 Linder Ulrica		

1-3 ->SF rest ->R

Temperatur: -water 20 °C -air 23 °C Wind: 1.1m/sec 30°

Chief Official: John Leukemans (BEL) Course Umpires: Horvath (HUN) Chielewska (POL)
Starters: Otto Tomiuc (ROM) Finish Line judge: Gunter Byhan (GER)

VÝSLEDKOVÁ LISTINA / RESULT LIST

Datum/date 30.7.93

K4W 500 m

Junioren

Rozjízdky/Heat

3

Čas/Time 10:10

Závod
Race

60

			250 m	Total
1	ESP (4)	191 Aramburu Izaskum 193 Iglesias Andrea 195 Romero Antonia 192 Fernandez Cristina	49.82 (1)	1:43.00
2	SVK (6)	643 Kapisovska Svetlana 642 Hochschornerov Eva 641 Birvonova Miriam 645 Petranova Jana	51.80 (2) 01.98	1:45.87 02.87
3	KAZ (7)	772 Parfjonova Elena 773 Muravjova Natalja 774 Voseva Olga 775 Caileva Elena	52.68 (3) 02.86	1:47.01 04.01
4	USA (5)	732 Beyer Tara 734 White Olivia 731 Ashford Elizabeth 733 Goodrow Genevieve	53.12 (4) 03.30	1:47.12 04.12
5	FRA (2)	225 Koenders Nathalie 222 Bonnefoy Cecile 221 Agnes Isabelle 224 Gaultier Anne Sophie	53.50 (5) 03.68	1:48.70 05.70
6	JPN (1)	373 Sayuri Maruyama 374 Yoshika Oonishi 372 Sanae Nakao 371 Junko Kono	57.18 (6) 07.36	1:53.96 10.96
7	NED (3)	474 Mantel Linda 472 Ham Pauline 471 v.d. Endt Marion 473 Leeman Minouk	57.46 (7) 07.64	1:58.04 15.04

1-3 ->SF rest ->R

Temperatur: -water 20 °C -air 23 °C Wind: 0.7m/sec 70°

Chief Official: John Leukemans (BEL) Course Umpires: Amper D. (ISR) Bland P. (GBR)
Starters: Otto Tomiuc (ROM) Finish Line judge: Gunter Byhan (GER)



International
Canoe Federation

5th WORLD JUNIOR
CANOE
CHAMPIONSHIPS



29.7. - 1.8. 1993
RAČICE
CZECH REPUBLIC



VÝSLEDKOVÁ LISTINA / RESULT LIST

Datum/date 30.7.93

K2M 1000 m Junioři

Rozjízdky/Heat 1

Cas/Time 10:20

Závod
Race

61

			250 m	500 m	750 m	Total
1	BLR (1)	56 Borisik Piotr 63 Povalanskij Valerij	48.23 (1)	1:43.15 (1)	2:40.39 (1)	3:36.24
2	POL (5)	507 Aleksandrowicz W. 511 Markiewcz Jaroslaw	49.88 (2) 01.65	1:44.25 (2) 01.10	2:42.58 (2) 02.19	3:39.43 03.19
3	AUS (2)	15 Chalmers Luke 21 Ingerman Matthew	51.08 (4) 02.85	1:45.13 (3) 01.98	2:44.94 (3) 04.55	3:41.08 04.84
4	RSA (8)	586 Willis Russell 582 Du Toit Sakkie	50.37 (3) 02.14	1:46.94 (4) 03.79	2:45.49 (4) 05.10	3:41.24 05.00
5	KAZ (9)	776 Egorov Evgenij 777 Sobcinskij Dimitrij	52.29 (5) 04.06	1:47.49 (5) 04.34	2:46.98 (5) 06.59	3:43.11 06.87
6	GBR (4)	257 Smith David 251 Hemmings Brian	53.83 (8) 05.60	1:49.19 (6) 06.04	2:47.20 (6) 06.81	3:43.88 07.64
7	NED (7)	478 Visser Gido 475 de Rooy Maurits	52.62 (6) 04.39	1:50.73 (7) 07.58	2:50.55 (7) 10.16	3:49.70 13.46
8	TKM (6)	693 Chevtchouk Alexandre 692 Provotorov Dmitri	53.50 (7) 05.27	1:54.36 (8) 11.21	2:55.76 (8) 15.37	3:54.86 18.62
9	MLD (3)	462 Babitch Jeuri 463 Vitt Igori	58.17 (9) 09.94	2:00.50 (9) 17.35	3:07.02 (9) 26.63	4:12.11 35.87

1-2 ->SF rest ->R

Temperatur: -water 20 °C -air 23 °C wind: 1.2m/sec 120°

Chief Official: John Leukemans (BEL) Course Umpires: Janssens (BEL) Navasart (ROM)
Starters: Mike Moir (CAN) Finish Line judge: Gunter Byhan (GER)



Complete Office Equipment





International
Canoe Federation

5th WORLD JUNIOR
CANOE
CHAMPIONSHIPS



29.7. - 1.8. 1993
RACICE
CZECH REPUBLIC



Czech Canoe
Union

VÝSLEDKOVÁ LISTINA / RESULT LIST

Datum/date 30.7.93

K2M 1000 m Junioren

Rozjízdky/Heat 2

Cas/Time 10:30

Závod
Race

62

			250 m	500 m	750 m	Total
1	LAT (5)	404 Balabolins Kaspars 406 Buncis Edgars	50.20 (2) 00.66	1:45.34 (1)	2:40.76 (1)	3:35.53
2	ROM(9)	571 Sirbu Marian 562 Condrache Mihail	49.54 (1)	1:45.73 (2) 00.39	2:41.81 (2) 01.05	3:35.91 00.38
3	AUT (8)	32 Hinterhofer Martin 33 Stollnberger Markus	53.66 (6) 04.12	1:50.40 (6) 05.06	2:42.36 (4) 01.60	3:41.18 05.65
4	CZE (3)	153 Sarka Jan 141 Hejda Premysl	50.75 (3) 01.21	1:46.28 (3) 00.94	2:42.08 (3) 01.32	3:41.29 05.76
5	POR (2)	534 Fazenda Diogo 537 Silva Ludgero	51.68 (4) 02.14	1:48.48 (4) 03.14	2:46.70 (5) 05.94	3:42.61 07.08
6	DEN (4)	176 Olsen Rene 175 Korshin Andre	51.85 (5) 02.31	1:50.07 (5) 04.73	2:47.14 (6) 06.38	3:42.89 07.36
7	MEX(1)	447 Heredia Rafael 444 Dominguez Emilio	55.42 (7) 05.88	1:55.73 (7) 10.39	2:47.52 (7) 06.76	3:52.50 16.97
8	JPN (6)	376 Hiroaki Matsumoto 384 Takaichi Nakatsu	57.23 (8) 07.69	2:01.71 (8) 16.37	2:53.89 (8) 13.13	4:11.28 35.75
9	SLO (7)	627 Jakomin Dejan 629 Renner Marko	59.43 (9) 09.89	2:06.27 (9) 20.93	3:06.80 (9) 26.04	4:24.30 48.77

1-2 ->SF rest ->R

Temperatur: -water 20 °C -air 23 °C Wind: 0.5m/sec 120°

Chief Official: John Leukemans (BEL)

Course Umpires: Horvath (HUN) Chielewska (POL)

Starters: Mike Moir (CAN)

Finish Line judge: Gunter Byhan (GER)



COMPUTER SYSTEMS





International
Canoe Federation

5th WORLD JUNIOR
CANOE
CHAMPIONSHIPS



29.7. - 1.8. 1993
RAČICE
CZECH REPUBLIC



VÝSLEDKOVÁ LISTINA / RESULT LIST

Datum/date 30.7.93

K2M 1000 m Junioren

Rozjízdky/Heat 3

Cas/Time 10:40

Závod
Race **63**

			250 m	500 m	750 m	Total
1	BUL (4)	85 Karadjov Petar 86 Merkov Petar	50.09 (2) 00.22	1:45.57 (2) 00.55	2:38.02 (1)	3:32.08
2	GER (3)	272 Lehnert Sven 277 Schmiech Daniel	49.87 (1)	1:46.06 (3) 01.04	2:39.34 (3) 01.32	3:32.77 00.69
3	FRA (6)	237 Robert Yann 235 Rebours Loic	50.97 (4) 01.10	1:45.02 (1)	2:39.12 (2) 01.10	3:33.09 01.01
4	ARG (7)	7 Suaya Pablo 3 Basualto Ariel	52.12 (6) 02.25	1:47.82 (6) 02.80	2:41.53 (4) 03.51	3:34.83 02.75
5	BEL (1)	48 Vandenbruwaene Leslie 43 Maesen Bob	52.84 (8) 02.97	1:47.27 (5) 02.25	2:41.92 (5) -- 03.90	3:37.34 05.26
6	ITA (2)	360 Frattini Luca 355 Ciacchella Ottavio	52.67 (7) 02.80	1:48.97 (8) 03.95	2:42.58 (6) 04.56	3:38.06 05.98
7	LTU (8)	424 Gerulskis Edmundas 422 Balciunas Egidijus	51.57 (5) 01.70	1:46.66 (4) 01.64	2:42.85 (7) 04.83	3:40.41 08.33
8	NOR (5)	486 Fjeloheim Nils Olav 489 Sigurosen Stian	50.31 (3) 00.44	1:48.42 (7) 03.40	2:44.83 (8) 06.81	3:45.64 13.56

1-2 ->SF rest ->R

Temperatur: -water 20 °C -air 24 °C Wind: 1.4m/sec 50°

Chief Official: John Leukemans (BEL) Course Umpires: Amper D. (ISR) Bland P. (GBR)
Starters: Mike Moir (CAN) Finish Line judge: Gunter Byhan (GER)



Computer Office Equipment



VÝSLEDKOVÁ LISTINA / RESULT LIST

Datum/date 30.7.93

K2M 1000 m Junioren

Rozjízdka/Heat 4

Čas/Time 10:50

Závod
Race **64**

			250 m	500 m	750 m	Total
1	HUN (8)	333 Storcz Botond 330 Neuwirth Zsolt	48.66 (1)	1:42.05 (1)	2:35.33 (1)	3:28.00
2	SVK (6)	651 Kuzel Rastislav 655 Simocko Radovan	52.73 (5) 04.07	1:45.51 (2) 03.46	2:39.78 (2) 04.45	3:34.31 06.31
3	ESP (3)	201 Gonzales Jovino 204 Merchan Emilio	51.30 (2) 02.64	1:46.34 (4) 04.29	2:40.66 (3) 05.33	3:35.41 07.41
4	RUS (5)	599 Bazarov Alexandr 596 Sobolev	52.18 (4) 03.52	1:46.67 (5) 04.62	2:41.98 (4) 06.65	3:37.48 09.48
5	SWE (7)	678 Berglund Mats 680 Haglund Hans	51.47 (3) 02.81	1:46.06 (3) 04.01	2:42.20 (5) 06.87	3:40.09 12.09
6	KOR (4)	398 Nam Sung Ho 397 Moon Chul Wook	53.66 (6) 05.00	1:50.73 (6) 08.68	2:49.45 (6) 14.12	3:48.12 20.12
7	BRA (1)	72 Lozz Ricardo 73 Mattiello Bruno Lebr.	55.70 (7) 07.04	1:56.06 (7) 14.01	2:58.84 (7) 23.51	4:01.17 33.17
8	GRE (2)	300 Rountos Iorgos 302 Skoulariotis Georgos	1:04.37 (8) 15.71	2:11.33 (8) 29.28	3:18.28 (8) 42.95	4:25.94 57.94

1-2 ->SF rest ->R

Temperatur: -water 20 °C -air 24 °C Wind: 0.6m/sec 120°

Chief Official: John Leukemans (BEL) Course Umpires: Janssens (BEL) Navasart (ROM)
Starters: Mike Moir (CAN) Finish Line judge: Gunter Byhan (GER)



International
Canoe Federation

5th WORLD JUNIOR
CANOE
CHAMPIONSHIPS



29.7. - 1.8. 1993
RÁČICE
CZECH REPUBLIC



Czech Canoe
Union

VÝSLEDKOVÁ LISTINA / RESULT LIST

Datum/date 30.7.1993

Závod
Race **65**

NO RACE



COMPUTER SYSTEMS



Complete Office Equipment





International
Canoe Federation

5th WORLD JUNIOR
CANOE
CHAMPIONSHIPS



29.7. - 1.8. 1993
RACICE
CZECH REPUBLIC



Czech Canoe
Union

VÝSLEDKOVÁ LISTINA / RESULT LIST

Datum/date 30.7.93

C2M 1000 m Junioren

Rozjízdky/Heat 1

Čas/Time 11:10

Závod
Race **66**

			250 m	500 m	750 m	Total
1	CAN (7) 113 Phelan Richard 107 Buday Tamas	57.50 (2) 01.31	1:58.58 (2) 01.21	3:00.37 (1)	4:02.22	
2	CZE (2) 151 Pojezny Petr 148 Machac Jan	59.04 (3) 02.85	1:59.85 (3) 02.48	3:01.42 (3) 01.05	4:02.87 00.65	
3	UKR (5) 714 Pavlov Vyatcheslav 709 Korenyuk Valentin	56.19 (1)	1:57.37 (1)	3:00.87 (2) 00.50	4:04.56 02.34	
4	FRA (6) 233 Moreaux Denis 234 Normand Samuel	59.43 (4) 03.24	2:02.70 (4) 05.33	3:05.59 (4) 05.22	4:09.10 06.88	
5	USA (8) 737 Johnson Nate 735 Batlik Vaclav	1:02.89 (5) 06.70	2:10.23 (6) 12.86	3:19.05 (6) 18.68	4:25.83 23.61	
6	POR (3) 535 Oliveira Rui 536 Reis Helio	1:03.05 (6) 06.86	2:07.86 (5) 10.49	3:18.66 (5) 18.29	4:27.70 25.48	
7	EST (1) 215 Rumm Ranno 212 Hollo Mihkel	1:04.59 (7) 08.40	2:12.86 (7) 15.49	3:24.43 (7) 24.06	4:35.73 33.51	

1-3 ->SF rest ->R

Temperatur: -water 20 °C -air 24 °C Wind: 0.9m/sec 50°

Chief Official: John Leukemans (BEL) Course Umpires: Amper D. (ISR) Bland P. (GBR)
Starters: Mike Moir (CAN) Finish Line judge: Gunter Byhan (GER)



COMPUTER SYSTEMS

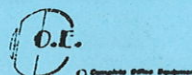

VÝSLEDKOVÁ LISTINA / RESULT LIST

Datum/date 30.7.93

C2M 1000 m Juniores Závod **67**
Rozjízdky/Heat 2 Cas/Time 11:20 Race

			250 m	500 m	750 m	Total
1	HUN (6)	324 Gyore Attila 322 Csikos Gergely	56.52 (1)	1:56.93 (1)	2:57.74 (1)	3:59.58
2	ESP (7)	203 Mascato David 206 Perez Gustavo	56.74 (2) 00.22	1:57.37 (2) 00.44	2:58.67 (2) 00.93	4:01.01 01.43
3	ITA (1)	367 Ventriglia Alessandro 364 Nardi Claudio	58.60 (6) 02.08	2:00.56 (4) 03.63	3:02.35 (4) 04.61	4:05.18 05.60
4	RUS (5)	598 Artemida Alexandr 604 Kapitonov Alexej	56.90 (3) 00.38	1:58.97 (3) 02.04	3:02.08 (3) 04.34	4:05.95 06.37
5	LAT (4)	410 Lagzdins Valentins 409 Kovalovs Sergejs	57.89 (4) 01.37	2:03.69 (5) 06.76	3:06.03 (5) 08.29	4:14.80 15.22
6	MEX (2)	443 Castaneda Jose Luis 442 Castaneda Benjamin	58.44 (5) 01.92	2:04.07 (6) 07.14	3:07.35 (6) 09.61	4:16.50 16.92

1-3 ->SF rest ->R

Temperatur: -water 20 °C -air 25 °C Wind: 0.8m/sec 70°

Chief Official: John Leukemans (BEL) Course Umpires: Janssens (BEL) Navasart (ROM)
Starters: Mike Moir (CAN) Finish Line judge: Gunter Byhan (GER)



International
Canoe Federation

5th WORLD JUNIOR
CANOE
CHAMPIONSHIPS



29.7. - 1.8. 1993
RAČICE
CZECH REPUBLIC



VÝSLEDKOVÁ LISTINA / RESULT LIST

Datum/date 30.7.93

C2M 1000 m Junioren

Rozjízdka/Heat

3

Cas/Time 11:30

Závod
Race

68

			250 m	500 m	750 m	Total
1	BUL (4)	88 Nikolov Rumén 82 Angelov Atanas	54.43 (1)	1:54.63 (1)	2:56.47 (2) 00.60	3:57.72
2	POL (5)	514 Pietrzak Artur 516 Rudny Arkadiusz	56.35 (3) 01.92	1:55.01 (2) 00.38	2:55.87 (1)	3:58.76 01.04
3	GER (6)	270 Hesse Jan 281 Zeisner Daniel	56.57 (4) 02.14	1:56.55 (3) 01.92	2:57.19 (3) 01.32	4:00.39 02.67
4	BLR (7)	60 Kirilenko Victor 68 Zujev Vitalij	56.08 (2) 01.65	1:57.21 (4) 02.58	3:03.23 (4) 07.36	4:11.32 13.60
5	GBR (1)	248 Crowther Stuart 253 Lane Malcolm	1:00.64 (7) 06.21	2:04.79 (6) 10.16	3:09.11 (5) 13.24	4:16.50 18.78
6	LTU (2)	427 Medvedev Konstantin 430 Polomosnov Andrej	59.81 (5) 05.38	2:04.13 (5) 09.50	3:10.48 (6) 14.61	4:18.87 21.15
7	JPN (3)	377 Hiroyuki Sato 380 Kiyoshige Saito	59.98 (6) 05.55	2:07.15 (7) 12.52	3:16.69 (7) 20.82	4:24.63 26.91

1-3 ->SF rest ->R

Temperatur: -water 20 °C -air 25 °C Wind: 0.7m/sec 60°

Chief Official: John Leukemans (BEL) Course Umpires: Horvath (HUN) Chielewska (POL)
Starters: Mike Moir (CAN) Finish Line judge: Gunter Byhan (GER)



COMPUTER SYSTEMS





International
Canoe Federation

5th WORLD JUNIOR
CANOE
CHAMPIONSHIPS



29.7. - 1.8. 1993
RAČICE
CZECH REPUBLIC



VÝSLEDKOVÁ LISTINA / RESULT LIST

Datum/date 30.7.93

K4M 1000 m Junioren

Závod
Race **69**

Rozjízdky/Heat 1

Čas/Time 11:40

			250 m	500 m	750 m	Total
1	ITA (3)	357 Blasi Andrea 366 Favalli Simone 368 Nardelli Ciro 363 Mate Davide	45.70 (1)	1:34.64 (1)	2:24.84 (1)	3:16.55
2	AUS (5)	14 Beresford-Peir Digby 13 Baggaley Nathan 17 Clayton James 18 Croker Glen	47.35 (4) 01.65	1:36.28 (2) 01.64	2:26.87 (2) 02.03	3:17.96 01.41
3	NOR (1)	486 Fjeloheim Nils Olav 489 Sigurosen Stian 487 Gjeroe Andreas 488 Rudolfsen Frooe	47.13 (3) 01.43	1:37.22 (3) 02.58	2:28.96 (3) 04.12	3:21.69 05.14
4	RSA (4)	581 Caldwell Stuart 585 Stenhouse Matthew 582 Du Toit Sakkie 583 Leonard Danie	47.57 (5) 01.87	1:37.99 (4) 03.35	2:30.33 (4) 05.49	3:21.88 05.33
5	UKR (7)	715 Sivko Alexandr 720 Zhembrovski Serguei 706 Berzin Serguei 713 Navitnyi Oleg	46.69 (2) 00.99	1:38.48 (5) 03.84	2:30.94 (5) 06.10	3:23.70 07.15
6	NED (6)	478 Visser Gido 475 de Rooy Maurits 476 Kossen Wouter 477 v.d. Pol Tobias	48.28 (6) 02.58	1:40.29 (6) 05.65	2:32.91 (6) 08.07	3:25.54 08.99
7	MEX (8)	446 Heinze Ralph 444 Dominguez Emilio 447 Heredia Rafael 449 Sierra Luis	48.66 (7) 02.96	1:45.24 (7) 10.60	2:40.00 (7) 15.16	3:33.06 16.51
8	JPN (2)	385 Yasuo Miyake 378 Kazunori Tagami 376 Hiroaki Matsumoto 384 Takaichi Nakatsu	52.18 (8) 06.48	1:49.52 (8) 14.88	2:48.24 (8) 23.40	3:45.36 28.81

1-2 →SF rest →R

Temperatur: -water 20 °C -air 26 °C Wind: 1.7m/sec 90°

Chief Official: John Leukemans (BEL) Course Umpires: Amper D. (ISR) Bland P. (GBR)
Starters: Mike Moir (CAN) Finish Line judge: Gunter Byhan (GER)



COMPUTER SYSTEMS

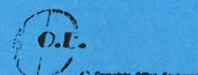



International
Canoe Federation

5th WORLD JUNIOR
CANOE
CHAMPIONSHIPS



29.7. - 1.8. 1993
RAČICE
CZECH REPUBLIC



VÝSLEDKOVÁ LISTINA / RESULT LIST

Datum/date 30.7.93

K4M 1000 m Junioren

Rozjízdky/Heat 2

Cas/Time 11:50

Závod
Race **70**

			250 m	500 m	750 m	Total
1	HUN (7)	320 Bauer Marton 330 Neuwirth Zsolt 317 Acs Tamas 327 Kovacs Akos	46.68 (3) 01.42	1:36.06 (2) 02.25	2:25.33 (2) 01.98	3:12.45
2	ROM (3)	562 Condrache Mihail 564 Enache Mihail 567 Hanches Ioan 571 Sirbu Marian	45.26 (1)	1:33.81 (1)	2:23.35 (1)	3:14.09 01.64
3	FRA (8)	238 Vossion Damien 229 Bocage Etienne 236 Richard Alban 231 Huguet Cyril	46.41 (2) 01.15	1:37.49 (4) 03.68	2:27.47 (5) 04.12	3:20.57 08.12
4	BLR (5)	57 Degtiariov Vladislav 63 Povalanskij Valerij 56 Borisik Piotr 64 Rubanov Gennadij	47.40 (5) 02.14	1:36.50 (3) 02.69	2:25.77 (3) 02.42	3:24.02 11.57
5	CAN (2)	112 Maksymiuk Daniel 108 Cobb Graham 116 Smith Dave 109 Illsley Scott	48.61 (7) 03.35	1:39.80 (6) 05.99	2:31.92 (6) 08.57	3:24.30 11.85
6	BEL (4)	45 Plomteux Laurens 44 Noppe Tom 42 Deslee Henk 47 Stevens David	48.33 (6) 03.07	1:40.79 (7) 06.98	2:32.58 (8) 09.23	3:25.04 12.59
7	ARG (1)	6 Linares Javier 8 Virkel Sebastian 5 Correa Javier 4 Canepa Diego	48.88 (8) 03.62	1:41.06 (8) 07.25	2:32.31 (7) 08.96	3:25.67 13.22
8	SVK (6)	649 Kasuba Lucian 647 Brodsky Ladislav 650 Kiss Roman 656 Straka Peter	47.01 (4) 01.75	1:38.92 (5) 05.11	2:27.20 (4) 03.85	3:27.17 14.72

1-2 ->SF rest ->R

Temperatur: -water 20 °C -air 26 °C Wind: 1.8m/sec 120°

Chief Official: John Leukemans (BEL) Course Umpires: Janssens (BEL) Navasart (ROM)
Starters: Mike Moir (CAN) Finish Line judge: Gunter Byhan (GER)



VÝSLEDKOVÁ LISTINA / RESULT LIST

Datum/date 30.7.93

K4M 1000 m Junioren

Rozjízdky/Heat 3

Cas/Time 12:00

Závod
Race **71**

		250 m	500 m	750 m	Total
1	GER (2) 279 Ulm Stefan 273 Mai Andre 272 Lehnert Sven 274 Patzack Jens	44.98 (1)	1:32.93 (1)	2:22.03 (1)	3:12.96
2	POL (7) 518 Wolff Pawel 515 Porowski Wlodzimierz 520 Zurek Ireneusz 509 Lakomy Pawel	46.52 (2) 01.54	1:35.68 (2) 02.75	2:25.22 (2) 03.19	3:16.39 03.43
3	SWE (1) 683 Oscarsson Markus 678 Berglund Mats 679 Edlund Daniel 677 Adlers Daniel	47.01 (3) 02.03	1:37.21 (4) 04.28	2:27.36 (4) 05.33	3:17.95 04.99
4	DEN (4) 172 Eilert Michael 177 Rasmussen Brian 179 Svenningen Claus 174 Heering Nicolai	47.51 (4) 02.53	1:36.77 (3) 03.84	2:26.81 (3) 04.78	3:18.20 05.24
5	LTU (6) 424 Gerulskis Edmundas 422 Balciunas Egidijus 431 Varnas Tomas 428 Mironeko Ruslan	49.26 (5) 04.28	1:39.19 (5) 06.26	2:31.15 (5) 09.12	3:25.64 12.68
6	USA (3) 736 Farnum Jim 738 Mowat Kai 740 Rocheleau Brian 741 Watanabe Chuck	50.14 (6) 05.16	1:42.16 (6) 09.23	2:33.73 (6) 11.70	3:27.99 15.03
7	SLO (5) 627 Jakomin Dejan 626 Dodic Mitja 628 Planinc Marjan 629 Renner Marko	58.82 (7) 13.84	2:00.34 (7) 27.41	3:01.58 (7) 39.55	4:05.12 52.16

1-2 ->SF rest ->R

Temperatur: -water 20 °C -air 26 °C Wind: 2.4m/sec 30°

Chief Official: John Leukemans (BEL) Course Umpires: Horvath (HUN) Chielewska (POL)
Starters: Mike Moir (CAN) Finish Line judge: Gunter Byhan (GER)



International
Canoe Federation

5th WORLD JUNIOR
CANOE
CHAMPIONSHIPS



29.7. - 1.8. 1993
RAČICE
CZECH REPUBLIC



VÝSLEDKOVÁ LISTINA / RESULT LIST

Datum/date 30.7.93

K4M 1000 m Junioren

Rozj/zdka/Heat

4

Čas/Time 12:10

Závod
Race

72

			250 m	500 m	750 m	Total
1	RUS (6)	600 Chertov Oleg 612 Tissin Andrei 610 Mironyuk Andrej 597 Andin Nikolaj	47.29 (3) 00.83	1:36.61 (1)	2:26.32 (1)	3:16.15
2	ESP (7)	202 Leal Carlos 198 Cuinas Antonio 200 Garcia Carlos 197 Busto Manuel	47.07 (2) 00.61	1:37.49 (3) 00.88	2:26.87 (2) 00.55	3:16.56 00.41
3	CZE (3)	159 Vanicek Vit 140 Dvorak Martin 157 Termer Vlastimil 158 Tonder Tomas	48.66 (5) 02.20	1:38.20 (4) 01.59	2:28.08 (4) 01.76	3:18.98 02.83
4	LAT (4)	404 Balabolins Kaspars 406 Buncis Edgars 412 Zalupe Kristaps 407 Greizis Ugis	46.46 (1)	1:37.00 (2) 00.39	2:27.86 (3) 01.54	3:22.07 05.92
5	FIN (1)	792 Keso Mikko 793 Ruokonen Riku 794 Winquist Simon 795 Mikkonen Kalle	49.76 (6) 03.30	1:41.77 (6) 05.16	2:34.72 (6) 08.40	3:28.00 11.85
6	POR (2)	537 Silva Ludgero 538 Sousa Jose 534 Fazenda Diogo 533 Almeida Carlos	47.89 (4) 01.43	1:40.29 (5) 03.68	2:34.34 (5) 08.02	3:31.83 15.68
7	KOR (5)	398 Nam Sung Ho 397 Moon Chul Wook 394 Kim Yong Kyo 395 Lee Kyung Soo	50.14 (7) 03.68	1:44.30 (7) 07.69	2:39.67 (7) 13.35	3:34.24 18.09

1-2 →SF rest →R

Temperatur: -water 20 °C -air 27 °C Wind: 2.4m/sec 30°

Chief Official: John Leukemans (BEL) Course Umpires: Amper D. (ISR) Bland P. (GBR)
Starters: Mike Moir (CAN) Finish Line judge: Gunter Byhan (GER)



Complete Office Equipment





International
Canoe Federation

5th WORLD JUNIOR
CANOE
CHAMPIONSHIPS



29.7. - 1.8. 1993
RACICE
CZECH REPUBLIC



Czech Canoe
Union

VÝSLEDKOVÁ LISTINA / RESULT LIST

Datum/date 30.7.93

C4M 1000 m Junioiren

Závod
Race **73**

Rozjřzdzka/Heat 1

Čas/Time 12:20

			250 m	500 m	750 m	Total
1	GER (7)	267 Gille Christian 278 Tiedge Rene 280 Vesely Kay 266 Bebber Ricardo	50.42 (1)	1:45.12 (1)	2:39.72 (1)	3:36.24
2	POL (3)	519 Zajaczkowski Slawomir 517 Watkowski Norbert 512 Midloch Pawel 513 Midloch Piotr	55.20 (4) 04.78	1:47.81 (3) 02.69	2:43.29 (3) 03.57	3:42.28 06.04
3	ITA (4)	367 Ventriglia Alessandro 364 Nardi Claudio 356 Bedin Andrea 358 Bonacina Antonio	57.28 (5) 06.86	1:50.45 (5) 05.33	2:47.85 (5) 08.13	3:44.92 08.68
4	GRE (5)	305 Zachos Lukas 303 Terzithis Teofanis 294 Arapis Athanasios 297 Kiriazis Dimitriou	52.83 (3) 02.41	1:49.63 (4) 04.51	2:47.41 (4) 07.69	3:52.55 16.31
5	BUL (2)	83 Atanasov Dimitar 84 Atanasov Stanimir 89 Petrov Genaedi 90 Spasov Trendafil	52.12 (2) 01.70	1:46.66 (2) 01.54	2:42.96 (2) 03.24	3:57.16 20.92
6	LTU (8)	429 Paulauskas Dainius 427 Medvedev Konstantin 430 Polomosnov Andrej 426 Jonkus Mindaugas	1:00.69 (6) 10.27	1:58.25 (6) 13.13	3:00.43 (6) 20.71	4:03.92 27.68
7	JPN (1)	375 Eiji Uejoy 386 Yoshimi Hosotani 377 Hiroyuki Sato 380 Kiyoshige Saito	1:04.86 (7) 14.44	2:04.13 (7) 19.01	3:07.95 (7) 28.23	4:14.08 37.84

1-2 ->F rest ->SF

Temperatur: -water 20 °C -air 27 °C Wind: 3.0m/sec 50°

Chief Official: John Leukemans (BEL) Course Umpires: Janssens (BEL) Navasart (ROM)
Starters: Mike Moir (CAN) Finish Line judge: Gunter Byhan (GER)



Complete Office Equipment



VÝSLEDKOVÁ LISTINA / RESULT LIST

Datum/date 30.7.93

C4M 1000 m

Junioren

Rozjízdky/Heat 2

Cas/Time 12:30

Závod
Race **74**

			250 m	500 m	750 m	Total
1	ROM(5)	565 Glavan Marcel 568 Huidu Florian 566 Grigore Sami 570 Mardale Cristian	50.31 (1)	1:44.90 (1)	2:39.17 (1)	3:33.97
2	HUN(1)	319 Balgovits Gabor 335 Telek Gabor 331 Redenszki Antal 324 Gyore Attila	52.28 (2) 01.97	1:47.76 (2) 02.86	2:42.30 (2) 03.13	3:35.81 01.84
3	UKR (7)	717 Tchounyak Alexandr 714 Pavlov Vyatcheslav 710 Kovaltchouk Andrei 709 Korenyuk Valentin	52.61 (3) 02.30	1:48.20 (3) 03.30	2:43.40 (3) 04.23	3:36.05 02.08
4	CZE (2)	149 Marisko Jan 137 Brecka Jan 142 Juttner Tomas 148 Machac Jan	53.05 (4) 02.74	1:50.18 (5) 05.28	2:46.64 (5) 07.47	3:41.52 07.55
5	FRA (3)	230 Ethuin David 232 Lavigne Yannick 227 Assa Martin 228 Barbey Laurent	53.33 (5) 03.02	1:51.22 (6) 06.32	2:47.79 (6) 08.62	3:41.75 07.78
6	RUS (6)	607 Lantsayev Vasilij 601 Elizarov Maxim 606 Kruzshilin Oleg 602 Gherasiov Victor	53.66 (6) 03.35	1:49.96 (4) 05.06	2:45.65 (4) 06.48	3:54.69 20.72
7	BLR (4)	68 Zujev Vitalij 60 Kirilenko Victor 66 Zhookovskij Dmitrij 62 Markosian Mikhail	54.65 (7) 04.34	1:53.53 (7) 08.63	2:57.84 (7) 18.67	3:58.30 24.33

1-2 ->F rest ->SF

Temperatur: -water 20 °C -air 27 °C Wind: 1.3m/sec 90°

Chief Official: John Leukemans (BEL) Course Umpires: Horvath (HUN) Chielewska (POL)
Starters: Mike Moir (CAN) Finish Line judge: Gunter Byhan (GER)



International
Canoe Federation

5th WORLD JUNIOR
CANOE
CHAMPIONSHIPS



29.7. - 1.8. 1993
RAČICE
CZECH REPUBLIC



VÝSLEDKOVÁ LISTINA / RESULT LIST

Datum/date 30.7.93

K1M 1000 m Junioren

Opr.jízda/Repetage 1

Cas/Time 16:03

Závod
Race **75**

			250 m	500 m	750 m	Total
1	SVK (6)	651 Kuzel Rastislav	58.93 (5) 02.96	1:57.92 (2) 01.48	2:57.79 (2) 00.22	3:54.66
2	UKR (5)	711 Kutcherenko Serguei	55.97 (1)	1:56.44 (1)	2:57.57 (1)	3:55.77 01.11
3	FIN (1)	791 Latvamaki Kimmo	56.40 (3) 00.43	1:58.42 (3) 01.98	3:00.87 (3) 03.30	4:05.52 10.86
4	BRA (7)	71 Lopes Denis Ferre	56.13 (2) 00.16	1:59.02 (4) 02.58	3:03.83 (4) 06.26	4:09.34 14.68
5	CZE (3)	140 Dvorak Martin	1:01.07 (8) 05.10	2:06.27 (7) 09.83	3:07.84 (6) 10.27	4:09.82 15.16
6	GBR (2)	256 Sargeant Ian	57.17 (4) 01.20	2:00.83 (5) 04.39	3:07.02 (5) 09.45	4:11.11 16.45
7	JPN (8)	379 Kazutoshi Mishima	59.54 (6) 03.57	2:03.03 (6) 06.59	3:08.94 (7) 11.37	4:15.52 20.86
8	GRE (9)	299 Montanaris Stelios	59.92 (7) 03.95	2:07.70 (8) 11.26	3:18.55 (8) 20.98	4:24.11 29.45
	POR (4)	533 Almeida Carlos				Don't ended

1-3+the best 4th ->SF rest ->out

Temperatur: -water 22 °C -air 28 °C Wind: 1.7m/sec 30°

Chief Official: John Leukemans (BEL) Course Umpires: Amper D. (ISR) Bland P. (GBR)
Starters: Mike Moir (CAN) Finish Line judge: Gunter Byhan (GER)



COMPUTER SYSTEMS

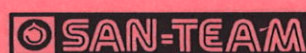

VÝSLEDKOVÁ LISTINA / RESULT LIST

Datum/date 30.7.93

K1M 1000 m Junioren Závod **76**
Opr.jízda/Repetage 2 Cas/Time 16:09 Race

			250 m	500 m	750 m	Total
1	BEL (4)	47 Stevens David	55.42 (1)	1:55.89 (1)	2:55.16 (1)	3:55.20
2	POL (6)	509 Lakomy Pawel	56.79 (3) 01.37	1:56.99 (2) 01.10	2:57.14 (2) 01.98	3:56.46 01.26
3	DEN (5)	174 Heering Nicolai	56.47 (2) 01.05	1:57.32 (3) 01.43	2:58.51 (3) 03.35	4:00.39 05.19
4	USA (7)	739 Osusky Juraj	58.61 (6) 03.19	2:01.17 (7) 05.28	3:03.62 (6) 08.46	4:02.95 07.75
5	ISR (3)	342 Hardoof Ronen	58.88 (7) 03.46	1:59.96 (4) 04.07	3:02.24 (4) 07.08	4:06.42 11.22
6	TKM (8)	693 Chevchouk Alexandre	58.17 (5) 02.75	2:00.29 (5) 04.40	3:02.57 (5) 07.41	4:06.61 11.41
7	RSA (2)	581 Caldwell Stuart	1:01.96 (9) 06.54	2:01.61 (8) 05.72	3:04.61 (7) 09.45	4:09.43 14.23
8	EST (1)	216 Vello Raul	59.27 (8) 03.85	2:03.36 (9) 07.47	3:09.17 (9) 14.01	4:13.06 17.86
9	MLD (9)	463 Vitt Igori	57.51 (4) 02.09	2:00.67 (6) 04.78	3:04.99 (8) 09.83	4:13.38 18.18

1-3+the best 4th ->SF rest ->out

Temperatur: -water 22 °C -air 28 °C Wind: 1.2m/sec 30°

Chief Official: John Leukemans (BEL) Course Umpires: Janssens (BEL) Navasart (ROM)
Starters: Mike Moir (CAN) Finish Line judge: Gunter Byhan (GER)



International
Canoe Federation

5th WORLD JUNIOR
CANOE
CHAMPIONSHIPS



29.7. - 1.8. 1993
RAČICE
CZECH REPUBLIC



Czech Canoe
Union

VÝSLEDKOVÁ LISTINA / RESULT LIST

Datum/date 30.7.93

K1M 1000 m Junioren

Opr. jízda/Repetage 3

Cas/Time 16:20

Závod
Race **77**

			250 m	500 m	750 m	Total
1	SWE (4)	682 Nilsson Henrik	57.12 (1)	1:57.37 (1)	2:59.82 (1)	4:00.16
2	RUS (5)	612 Tissin Andrei	58.33 (5) 01.21	1:57.65 (2) 00.28	3:00.37 (2) 00.55	4:01.78 01.62
3	SUI (7)	661 Bachmann Adrian	57.39 (2) 00.27	1:58.74 (3) 01.37	3:02.68 (4) 02.86	4:02.32 02.16
4	LAT (6)	411 Petersons Gundars	58.00 (4) 00.88	1:59.73 (5) 02.36	3:02.02 (3) 02.20	4:03.07 02.91
5	MEX (3)	446 Heinze Ralph	59.10 (6) 01.98	2:02.15 (6) 04.78	3:04.38 (6) 04.56	4:04.54 04.38
6	NED (8)	477 v.d. Pol Tobias	57.78 (3) 00.66	1:58.96 (4) 01.59	3:03.17 (5) 03.35	4:08.13 07.97
7	LTU (2)	431 Varnas Tomas	1:00.58 (7) 03.46	2:06.10 (7) 08.73	3:14.10 (7) 14.28	4:19.63 19.47
8	KOR (1)	395 Lee Kyung Soo	1:01.62 (8) 04.50	2:08.03 (8) 10.66	3:15.97 (8) 16.15	4:21.19 21.03

1-3+the best 4th ->SF rest ->out

Temperatur: -water 22 °C -air 28 °C Wind: 0.2m/sec 90°

Chief Official: John Leukemans (BEL) Course Umpires: Horvath (HUN) Chielewska (POL)
Starters: Mike Moir (CAN) Finish Line judge: Gunter Byhan (GER)



COMPUTER SYSTEMS

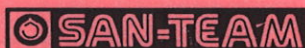

Complete Office Equipment





International
Canoe Federation

5th WORLD JUNIOR
CANOE
CHAMPIONSHIPS



29.7. - 1.8. 1993
RAČICE
CZECH REPUBLIC



Czech Canoe
Union

VÝSLEDKOVÁ LISTINA / RESULT LIST

Datum/date 30.7.93

C1M 1000 m Juniores Závod/Race **78**
Opr. jízda/Repetage 1 Cas/Time 16:30

			250 m	500 m	750 m	Total
1	DEN (4) 178	Scales Carsten	1:04.92 (4) 02.09	2:12.81 (3) 01.76	3:21.02 (1)	4:28.08
2	SVK (5) 654	Pales Andrej	1:04.21 (2) 01.38	2:11.87 (2) 00.82	3:21.46 (3) 00.44	4:29.06 00.98
3	BLR (6) 66	Zhookevskij Dmitrij	1:02.83 (1)	2:11.05 (1)	3:21.24 (2) 00.22	4:29.27 01.19
4	GBR (7) 254	Love Jonathan	1:06.07 (6) 03.24	2:15.39 (4) 04.34	3:26.79 (4) 05.77	4:36.36 08.28
5	LTU (3) 429	Paulauskas Dainius	1:06.73 (7) 03.90	2:18.14 (7) 07.09	3:28.00 (5) 06.98	4:42.50 14.42
6	KAZ (8) 778	Kirnenko Sergej	1:07.56 (8) 04.73	2:18.52 (8) 07.47	3:32.01 (7) 10.99	4:44.78 16.70
7	GRE (2) 294	Arapis Athanasios	1:05.30 (5) 02.47	2:15.77 (5) 04.72	3:29.92 (6) 08.90	4:46.39 18.31
8	EST (1) 213	Koiva Kaspar	1:04.54 (3) 01.71	2:16.32 (6) 05.27	3:33.60 (8) 12.58	4:48.52 20.44
9	POR (9) 536	Reis Helio	1:08.27 (9) 05.44	2:21.21 (9) 10.16	3:36.95 (9) 15.93	4:51.17 23.09

1-4+the best 5th ->SF rest ->out

Temperatur: -water °C -air °C Wind: m/sec

Chief Official: John Leukemans (BEL) Course Umpires: Amper D. (ISR) Bland P. (GBR)
Starters: Mike Moir (CAN) Finish Line judge: Gunter Byhan (GER)



COMPUTER SYSTEMS

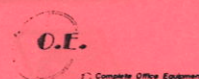

VÝSLEDKOVÁ LISTINA / RESULT LIST

Datum/date 30.7.93

C1M 1000 m Junioren

Opr. jízda/Repetage 2

Cas/Time 16:42

Závod
Race **79**

			250 m	500 m	750 m	Total
1	ITA (5)	356 Bedin Andrea	1:03.88 (2) 02.09	2:11.39 (2) 00.66	3:19.66 (1)	4:29.58
2	UKR (6)	708 Dvoulyat Serguei	1:01.79 (1)	2:10.73 (1)	3:21.14 (2) 01.48	4:31.44 01.86
3	MEX (4)	443 Castaneda Jose Luis	1:05.47 (5) 03.68	2:13.14 (3) 02.41	3:23.23 (3) 03.57	4:31.97 02.39
4	RUS (3)	607 Lantsayev Vasilij	1:06.02 (6) 04.23	2:14.57 (5) 03.84	3:24.00 (5) 04.34	4:32.65 03.07
5	FRA (8)	230 Ethuin David	1:05.26 (4) 03.47	2:13.42 (4) 02.69	3:23.50 (4) 03.84	4:34.61 05.03
6	KOR (7)	396 Lee Seoung Woo	1:04.87 (3) 03.08	2:14.85 (6) 04.12	3:27.84 (6) 08.18	4:42.18 12.60
7	JPN (2)	383 Shigeo Tanaka	1:07.07 (7) 05.28	2:17.26 (7) 06.53	3:29.98 (7) 10.32	4:45.10 15.52
8	SLO (9)	627 Jakomin Dejan	1:15.47 (8) 13.68	2:39.07 (8) 28.34	4:03.71 (8) 44.05	5:25.86 56.28

1-4+the best 5th ->SF rest ->out

Temperatur: -water 22 °C -air 28 °C Wind: 1.5m/sec 40°

Chief Official: John Leukemans (BEL)

Course Umpires: Janssens (BEL) Navasart (ROM)

Starters: Mike Moir (CAN)

Finish Line judge: Gunter Byhan (GER)



International
Canoe Federation

5th WORLD JUNIOR
CANOE
CHAMPIONSHIPS



29.7. - 1.8. 1993
RACICE
CZECH REPUBLIC



VÝSLEDKOVÁ LISTINA / RESULT LIST

Datum/date 30.7.1993

Závod
Race **80**

NO RACE

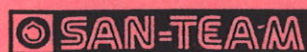

VÝSLEDKOVÁ LISTINA / RESULT LIST

Datum/date 30.7.93

K4W 500 m

Junioren

Závod

81

Opr.jízda/Repetage 1

Cas/Time 16:59

Race

			250 m	Total
1	BLR (6)	51 Bet Elena 52 Maslova Natalia 54 Subotenko Olga 53 Pajgraj Nadezhda	52.18 (2) 00.22	1:45.39
2	UKR (3)	702 Kovalenko Anna 703 Litchman Tatiana 705 Yurtchenko Ekaterina 704 Tchaytchouk Alevtina	51.96 (1)	1:46.01 00.62
3	RUS (5)	595 Tishyenko Tatyana 591 Anikeyeva Yuliya 593 Minayeva Marina 592 Kononova Yuliya	53.22 (3) 01.26	1:46.57 01.18
4	USA (4)	732 Beyer Tara 734 White Olivia 731 Ashford Elizabeth 733 Goodrow Genevieve	53.83 (4) 01.87	1:48.20 02.81
5	NED (2)	474 Mantel Linda 472 Ham Pauline 471 v.d. Endt Marion 473 Leeman Minouk	59.65 (5) 07.69	2:01.04 15.65
6	SLO (7)	624 Labignan Sandra 622 Culibrk Dunja 625 Strupar Zaneta 623 Kozel Lea	1:06.90 (6) 14.94	2:16.04 30.65

1-4+the best 5th ->SF rest ->out

Temperatur: -water 22 °C -air 29 °C Wind: 0.7m/sec 60°

Chief Official: John Leukemans (BEL)

Course Umpires: Amper D. (ISR) Bland P. (GBR)

Starters: Otto Tomiuc (ROM)

Finish Line judge: Gunter Byhan (GER)



International
Canoe Federation

5th WORLD JUNIOR
CANOE
CHAMPIONSHIPS



29.7. - 1.8. 1993
RAČICE
CZECH REPUBLIC



Czech Canoe
Union

VÝSLEDKOVÁ LISTINA / RESULT LIST

Datum/date 30.7.93

K4W 500 m

Junioren

Závod

82

Opr.jízda/Repetage 2

Cas/Time 17:10

Race

			250 m	Total
1	SWE (8)	674 Karlsson Therese 671 Augustsson Lisen 672 Hamrin Jenny 675 Linder Ulrica	52.90 (2) 00.44	1:47.72
2	CZE (5)	134 Hlucha Katerina 131 Borkovcova Sarka 133 Hekova Katerina 136 Pergnerova Milena	52.46 (1)	1:48.09 00.37
3	CAN (4)	102 Giles Kristina 103 Mckenzie Laura 105 Prince Karina 101 Furneaux Karen	53.72 (3) 01.26	1:49.10 01.38
4	FRA (6)	225 Koenders Nathalie 222 Bonnefoy Cecile 221 Agnes Isabelle 224 Gaultier Anne Sophie	54.05 (4) 01.59	1:49.48 01.76
5	NOR (3)	483 Halano May Lise 484 Knuosen Christine 482 Fjeloheim Marianne 481 Berntsen Anne Grete	55.15 (6) 02.69	1:50.64 02.92
6	JPN (7)	373 Sayuri Maruyama 374 Yoshika Oonishi 372 Sanae Nakao 371 Junko Kono	54.76 (5) 02.30	1:53.00 05.28

1-4+the best 5th ->SF rest ->out

Temperatur: -water 22 °C -air 29 °C Wind: 0.7m/sec 60°

Chief Official: John Leukemans (BEL) Course Umpires: Janssens (BEL) Navasart (ROM)
Starters: Otto Tomiuc (ROM) Finish Line judge: Gunter Byhan (GER)

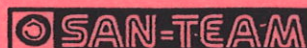

VÝSLEDKOVÁ LISTINA / RESULT LIST

Datum/date 30.7.93

K2M 1000 m Junioren

Opr. jízda/Repetage 1

Cas/Time 17:22

Závod
Race

83

			250 m	500 m	750 m	Total
1	ARG (6)	7 Suaya Pablo 3 Basualto Ariel	51.03 (2) 00.44	1:47.21 (3) 00.65	2:43.79 (1)	3:39.17
2	ESP (4)	201 Gonzales Jovino 204 Merchan Emilio	51.90 (3) 01.31	1:46.56 (1)	2:44.34 (2) 00.55	3:40.28 01.11
3	LTU (8)	424 Gerulskis Edmundas 422 Balciunas Egidijus	54.82 (7) 04.23	1:50.68 (5) 04.12	2:46.92 (4) 03.13	3:41.45 02.28
4	GBR (7)	257 Smith David 251 Hemmings Brian	53.77 (5) 03.18	1:50.89 (6) 04.33	2:48.02 (5) 04.23	3:43.36 04.19
5	AUS (5)	15 Chalmers Luke 21 Ingerman Matthew	53.50 (4) 02.91	1:49.63 (4) 03:07	2:48.40 (6) 04.61	3:44.67 05.50
6	POR (3)	534 Fazenda Diogo 537 Silva Ludgero	50.59 (1)	1:46.78 (2) 00.22	2:46.04 (3) 02.25	3:45.91 06.74
7	KOR (2)	398 Nam Sung Ho 397 Moon Chul Wook	54.32 (6) 03.73	1:51.99 (7) 05.43	2:50.38 (7) 06.59	3:49.02 09.85
8	MLD(9)	462 Babitch Jeuri 463 Vitt Igori	55.48 (8) 04.89	1:53.04 (8) 06.48	2:54.39 (8) 10.60	3:56.67 17.50
9	JPN (1)	376 Hiroaki Matsumoto 384 Takaichi Nakatsu	57.23 (9) 06.64	2:01.77 (9) 15.21	3:10.15 (9) 26.36	4:16.89 37.72

1-3+the best 4th ->SF rest ->out

Temperatur: -water 22 °C -air 29 °C Wind: 1.5m/sec 40°

Chief Official: John Leukemans (BEL)
Starters: Mike Moir (CAN)

Course Umpires: Horvath (HUN) Chielewska (POL)
Finish Line judge: Gunter Byhan (GER)

VÝSLEDKOVÁ LISTINA / RESULT LIST

Datum/date 30.7.93

K2M 1000 m Junioren

Závod
Race

84

Opr.jízda/Repetage 2

Cas/Time 17:32

			250 m	500 m	750 m	Total
1	NOR (9)	486 Fjeloheim Nils Olav 489 Sigurosen Stian	51.02 (1)	1:45.84 (2) 00.28	2:42.80 (1)	3:39.10
2	RUS (6)	599 Bazarov Alexandr 596 Sobolev	52.89 (4) 01.87	1:47.54 (3) 01.98	2:45.10 (3) 02.30	3:39.53 00.43
3	BEL (3)	48 Vandenbruwaene Leslie 43 Maesen Bob	52.29 (2) 01.27	1:45.56 (1)	2:43.02 (2) 00.22	3:40.04 00.94
4	DEN (7)	176 Olsen Rene 175 Korshin Andre	52.67 (3) 01.65	1:49.03 (4) 03.47	2:46.92 (4) 04.12	3:42.65 03.55
5	RSA (4)	586 Willis Russell 582 Du Toit Sakkie	53.44 (5) 02:42..	1:49.19 (5) 03.63	2:47.74 (6) -- 04.94	3:44.20 05.10
6	NED (2)	478 Visser Gido 475 de Rooy Maurits	53.89 (6) 02.87	1:50.84 (7) 05.28	2:47.52 (5) 04.72	3:44.37 05.27
7	AUT (5)	32 Hinterhofer Martin 33 Stollnberger Markus	54.03 (7) 03.01	1:50.62 (6) 05.06	2:48.34 (7) 05.54	3:44.45 05.35
8	BRA (8)	72 Lozz Ricardo 73 Mattiello Bruno Lebr.	57.56 (8) 06.54	1:59.68 (8) 14.12	3:05.04 (8) 22.24	4:07.71 28.61
9	SLO (1)	627 Jakomin Dejan 629 Rener Marko	58.49 (9) 07.47	2:07.75 (9) 22.19	3:17.35 (9) 34.55	4:25.01 45.91

1-3+the best 4th ->SF rest ->out

Temperatur: -water 22 °C -air 28 °C Wind: 1.0m/sec 60°

Chief Official: John Leukemans (BEL) Course Umpires: Amper D. (ISR) Bland P. (GBR)
Starters: Mike Moir (CAN) Finish Line judge: Gunter Byhan (GER)



International
Canoe Federation

5th WORLD JUNIOR
CANOE
CHAMPIONSHIPS



29.7. - 1.8. 1993
RACICE
CZECH REPUBLIC



VÝSLEDKOVÁ LISTINA / RESULT LIST

Datum/date 30.7.93

K2M 1000 m Junioren

Opr.jízda/Repetage 3

Cas/Time 17:41

Závod
Race **85**

			250 m	500 m	750 m	Total
1	FRA (5)	237 Robert Yann 235 Rebours Loic	50.48 (1)	1:44.69 (1)	2:40.28 (1)	3:35.02
2	SWE (3)	678 Berglund Mats 680 Haglund Hans	50.70 (2) 00.22	1:45.74 (2) 01.05	2:42.31 (3) 02.03	3:36.04 01.02
3	CZE (4)	153 Sarka Jan 141 Hejda Premysl	51.36 (3) 00.88	1:46.01 (3) 01.32	2:41.82 (2) 01.54	3:36.30 01.28
4	ITA (7)	360 Frattini Luca 355 Ciacchella Ottavio	52.07 (4) 01.59	1:47.00 (4) 02.31	2:42.58 (4) 02.30	3:36.40 01.38
5	MEX (2)	447 Heredia Rafael 444 Dominguez Emilio	54.60 (6) 04.12	1:51.31 (5) 06.62	2:53.24 (5) 12.96	3:53.81 18.79
6	TKM (8)	693 Chevtchouk Alexandre 692 Provotorov Dmitri	54.16 (5) 03.68	1:53.43 (6) 08.74	2:56.15 (6) 15.87	3:57.88 22.86
7	GRE (1)	300 Rountos Iorgos 302 Skoulariotis Georgos	1:02.18 (7) 11.70	2:08.53 (7) 23.84	3:15.10 (7) 34.82	4:22.14 47.12
	KAZ (6)	776 Egorov Evgenij 777 Sobcinskij Dimitrij				Diskvalification

1-3+the best 4th ->SF rest ->out

Temperatur: -water °C -air °C Wind: m/sec

Chief Official: John Leukemans (BEL) Course Umpires: Janssens (BEL) Navasart (ROM)
Starters: Mike Moir (CAN) Finish Line judge: Gunter Byhan (GER)



COMPUTER SYSTEMS

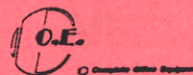
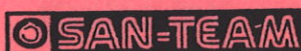

VÝSLEDKOVÁ LISTINA / RESULT LIST

Datum/date 30.7.93

C2M 1000 m		Junioři	Závod Race 86			
Opr. jízda/Repetage	1		Cas/Time	17:49		
			250 m	500 m	750 m	Total
1	BLR (5)	60 Kirilenko Victor 68 Zujev Vitalij	58.00 (1)	2:01.38 (1)	3:06.36 (1)	4:10.97
2	LAT (6)	410 Lagzdins Valentins 409 Kovalovs Sergejs	1:00.53 (2) 02.53	2:05.45 (2) 04.07	3:13.45 (2) 07.09	4:18.22 07.25
3	LTU (3)	427 Medvedev Konstantin 430 Polomosnov Andrej	1:02.61 (3) 04.61	2:08.92 (3) 07.54	3:16.47 (3) 10.11	4:21.09 10.12
4	USA (4)	737 Johnson Nate 735 Batlik Vaclav	1:05.08 (5) 07.08	2:12.92 (5) 11.54	3:20.04 (4) 13.68	4:24.93 13.96
5	EST (7)	215 Rumm Ranno 212 Hollo Mihkel	1:03.77 (4) 05.77	2:11.38 (4) 10.00	3:23.17 (5) 16.81	4:35.14 24.17

1-4+the best 5th ->SF

Temperatur: -water 22 °C -air 28 °C Wind: 0.4m/sec 60°

Chief Official: John Leukemans (BEL) Course Umpires: Horvath (HUN) Chielewska (POL)
Starters: Mike Moir (CAN) Finish Line judge: Gunter Byhan (GER)



International
Canoe Federation

5th WORLD JUNIOR
CANOE
CHAMPIONSHIPS



29.7. - 1.8. 1993
RAČICE
CZECH REPUBLIC



VÝSLEDKOVÁ LISTINA / RESULT LIST

Datum/date 30.7.93

C2M 1000 m

Junioren

Závod
Race

87

Opr.jízda/Repetage 2

Cas/Time 18:01

			250 m	500 m	750 m	Total
1	FRA (5)	233 Moreaux Denis 234 Normand Samuel	1:01.24 (3) 00.72	2:03.25 (2) 01.02	3:08.21 (1)	4:11.38
2	RUS (4)	598 Artemida Alexandr 604 Kapitonov Alexej	1:00.52 (1)	2:02.23 (1)	3:09.69 (2) 01.48	4:13.85 02.47
3	MEX (7)	443 Castaneda Jose Luis 442 Castaneda Benjamin	1:01.73 (4) 01.21	2:03.79 (3) 01.56	3:10.95 (3) 02.74	4:15.01 03.63
4	GBR (6)	248 Crowther Stuart 253 Lane Malcolm	1:00.85 (2) 00.33	2:04.89 (4) 02.66	3:11.23 (4) 03.02	4:16.28 04.90
5	JPN (2)	377 Hiroyuki Sato 380 Kiyoshige Saito	1:02.17 (5) 01.65	2:05.68 (5) 03.45	3:15.84 (5) 07.63	4:23.72 12.34
6	POR (3)	535 Oliveira Rui 536 Reis Helio	1:02.56 (6) 02.04	2:07.35 (6) 05.12	3:17.71 (6) 09.50	4:29.05 17.67

1-4+the best 5th ->SF rest ->out

Temperatur: -water 22 °C -air 27 °C Wind: 0.6m/sec 30°

Chief Official: John Leukemans (BEL)

Course Umpires: Amper D. (ISR) Bland P. (GBR)

Starters: Mike Moir (CAN)

Finish Line judge: Gunter Byhan (GER)



COMPUTER SYSTEMS

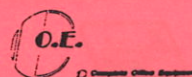
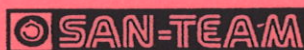



International
Canoe Federation

5th WORLD JUNIOR
CANOE
CHAMPIONSHIPS



29.7. - 1.8. 1993
RAČICE
CZECH REPUBLIC



VÝSLEDKOVÁ LISTINA / RESULT LIST

Datum/date 30.7.93

K4M 1000 m Junioren Závod Race **88**
Opr. jízda/Repetage 1 Cas/Time 18:17

			250 m	500 m	750 m	Total
1	FRA (5)	238 Vossion Damien 229 Bocage Etienne 236 Richard Alban 231 Huguet Cyril	47.89 (2) 00.22	1:37.05 (1)	2:28.46 (1)	3:19.54
2	DEN (4)	172 Eilert Michael 177 Rasmussen Brian 179 Svenningen Claus 174 Heering Nicolai	47.67 (1)	1:38.87 (2) 01.82	2:30.55 (3) 02.09	3:20.13 00.59
3	UKR (6)	715 Sivko Alexandr 720 Zhembrovski Serguei 706 Berzin Serguei 713 Navitnyi Oleg	48.39 (3) 00.72	1:39.19 (3) 02.14	2:30.28 (2) 01.82	3:20.89 01.35
4	FIN (3)	792 Keso Mikko 793 Ruokonen Riku 794 Winquist Simon 795 Mikkonen Kalle	49.05 (4) 01.38	1:40.68 (4) 03.63	2:32.86 (4) 04.40	3:21.73 02.19
5	ARG (2)	6 Linares Javier 8 Virkel Sebastian 5 Correa Javier 4 Canepa Diego	49.27 (5) 01.60	1:41.45 (5) 04.40	2:33.57 (5) 05.11	3:27.19 07.65
6	USA (7)	736 Farnum Jim 738 Mowat Kai 740 Rocheleau Brian 741 Watanabe Chuck	50.04 (7) 02.37	1:41.78 (6) 04.73	2:35.16 (6) 06.70	3:27.36 07.82
7	KOR (8)	398 Nam Sung Ho 397 Moon Chul Wook 394 Kim Yong Kyo 395 Lee Kyung Soo	49.82 (6) 02.15	1:42.05 (7) 05.00	2:36.54 (7) 08.08	3:29.41 09.87

1-3+the best 4th ->SF rest ->out

Temperatur: -water 22 °C -air 28 °C Wind: 0.6m/sec 30°

Chief Official: John Leukemans (BEL) Course Umpires: Janssens (BEL) Navasart (ROM)
Starters: Mike Moir (CAN) Finish Line judge: Gunter Byhan (GER)



COMPUTER SYSTEMS

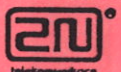



International
Canoe Federation

5th WORLD JUNIOR
CANOE
CHAMPIONSHIPS



29.7. - 1.8. 1993
RAČICE
CZECH REPUBLIC

Czech Canoe
Union

VÝSLEDKOVÁ LISTINA / RESULT LIST

Datum/date 30.7.93

K4M 1000 m Junioren

Opr.jízda/Repetage 2

Cas/Time 18:24

Závod
Race **89**

			250 m	500 m	750 m	Total
1	SVK (1)	649 Kasuba Lucian 647 Brodsky Ladislav 650 Kiss Roman 656 Straka Peter	47.35 (2) 00.33	1:36.72 (1)	2:26.87 (1)	3:15.77
2	LAT (6)	404 Balabolins Kaspars 406 Buncis Edgars 412 Zalupe Kristaps 407 Greizis Ugis	47.62 (3) 00.60	1:37.99 (2) 01.27	2:29.34 (2) 02.47	3:18.88 03.11
3	POR (8)	537 Silva Ludgero 538 Sousa Jose 534 Fazenda Diogo 533 Almeida Carlos	50.04 (6) 03.02	1:41.12 (6) 04.40	2:32.20 (6) 05.33	3:19.76 03.99
4	BLR (4)	57 Degtiariov Vladislav 63 Povalanskij Valerij 56 Borisik Piotr 64 Rubanov Gennadij	47.02 (1)	1:38.59 (3) 01.87	2:30.11 (3) 03.24	3:19.91 04.14
5	NOR (5)	486 Fjeloheim Nils Olav 489 Sigurosen Stian 487 Gjeroe Andreas 488 Rudolfsen Frooe	48.11 (4) 01.09	1:39.23 (4) 02.51	2:31.37 (4) 04.50	3:21.80 06.03
6	BEL (3)	45 Plomteux Laurens 44 Noppe Tom 42 Deslee Henk 47 Stevens David	48.77 (5) 01.75	1:40.02 (5) 03.30	2:31.87 (5) 05.00	3:22.12 06.35
7	LTU (7)	424 Gerulskis Edmundas 422 Balciunas Egidijus 431 Varnas Tomas 428 Mironeko Ruslan	50.20 (7) 03.18	1:43.48 (7) 06.76	2:35.05 (7) 08.18	3:25.14 09.37
8	MEX (2)	446 Heinze Ralph 444 Dominguez Emilio 447 Heredia Rafael 449 Sierra Luis	51.57 (8) 04.55	1:47.49 (8) 10.77	2:42.41 (8) 15.54	3:37.90 22.13

1-3+the best 4th ->SF rest ->out

Temperatur: -water 22 °C -air 28 °C Wind: 0.9m/sec 40°

Chief Official: John Leukemans (BEL)
Starters: Mike Moir (CAN)

Course Umpires: Horvath (HUN) Chielewska (POL)
Finish Line judge: Gunter Byhan (GER)

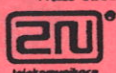

COMPUTER SYSTEMS

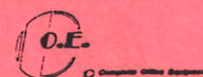
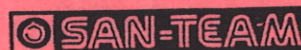



International
Canoe Federation

5th WORLD JUNIOR
CANOE
CHAMPIONSHIPS



29.7. - 1.8. 1993
RAČICE
CZECH REPUBLIC



Czech Canoe
Union

VÝSLEDKOVÁ LISTINA / RESULT LIST

Datum/date 30.7.93

K4M 1000 m		Junioren	Cas/Time 18:34			Závod Race	90
Opr.jízda/Repetage 3			250 m	500 m	750 m	Total	
1	CZE (4)	159 Vanicek Vit 140 Dvorak Martin 157 Termer Vlastimil 158 Tonder Tomas	47.84 (2) 00.49	1:39.14 (2) 00.49	2:29.56 (1)	3:20.55	
2	SWE (5)	683 Oscarsson Markus 678 Berglund Mats 679 Edlund Daniel 677 Adlers Daniel	47.35 (1)	1:38.65 (1)	2:30.39 (2) 00.83	3:22.09 01.54	
3	RSA (6)	581 Caldwell Stuart 585 Stenhouse Matthew 582 Du Toit Sakkie 583 Leonard Danie	48.89 (4) 01.54	1:40.02 (4) 01.37	2:31.43 (3) 01.87	3:22.70 02.15	
4	CAN (3)	112 Maksymiuk Daniel 108 Cobb Graham 116 Smith Dave 109 Illsley Scott	48.06 (3) 00.71	1:39.69 (3) 01.04	2:32.37 (4) 02.81	3:25.23 04.68	
5	NED (7)	478 Visser Gido 475 de Rooy Maurits 476 Kossen Wouter 477 v.d. Pol Tobias	51.03 (5) 03.68	1:42.71 (5) 04.06	2:37.25 (5) 07.69	3:27.76 07.21	
6	JPN (8)	385 Yasuo Miyake 378 Kazunori Tagami 376 Hiroaki Matsumoto 384 Takaichi Nakatsu	52.79 (6) 05.44	1:49.80 (6) 11.15	2:47.69 (6) 18.13	3:45.01 24.46	
7	SLO (2)	627 Jakomin Dejan 626 Dodic Mitja 628 Planinc Marjan 629 Renner Marko	59.98 (7) 12.63	2:03.97 (7) 25.32	3:06.75 (7) 37.19	4:08.92 48.37	

1-3+the best 4th ->SF rest ->out

Temperatur: -water 22 °C -air 28 °C Wind: 1.0m/sec 20°

Chief Official: John Leukemans (BEL) Course Umpires: Amper D. (ISR) Bland P. (GBR)
Starters: Mike Moir (CAN) Finish Line judge: Gunter Byhan (GER)



COMPUTER SYSTEMS

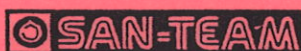



International
Canoe Federation

5th WORLD JUNIOR
CANOE
CHAMPIONSHIPS



29.7. - 1.8. 1993
RAČICE
CZECH REPUBLIC



Czech Canoe
Union

VÝSLEDKOVÁ LISTINA / RESULT LIST

Datum/date 31.7.93

K1M 500 m Juniořen

Mezijízda/Semifinal 1

Cas/Time 08:31

Závod
Race **91**

		250 m	Total
1	BLR (2) 57 Degtiariov Vladislav	50.36 (2) 00.55	1:43.38
2	AUS (4) 20 Evans Peter	49.81 (1)	1:43.47 00.09
3	GER (3) 279 Ulm Stefan	52.29 (6) 02.48	1:43.78 00.40
4	ESP (5) 202 Leal Carlos	51.90 (5) 02.09	1:44.06 00.68
5	FRA (6) 237 Robert Yann	51.63 (4) 01.82	1:45.23 01.85
6	FIN (7) 791 Latvamaki Kimmo	53.76 (9) 03.95	1:46.42 03.04
7	RUS (1) 600 Chertov Oleg	52.73 (7) 02.92	1:46.61 03.23
8	ROM(8) 564 Enache Mihail	53.44 (8) 03.63	1:47.19 03.81
9	MLD(9) 462 Babitch Jeuri	51.41 (3) 01.60	1:47.53 04.15

1-4+the best 5th ->F rest ->out

Temperatur: -water 22 °C -air 21 °C Wind: 1.4m/sec 170°

Chief Official: John Leukemans (BEL) Course Umpires: Janssens (BEL) Navasart (ROM)

Starters: Otto Tomiuc (ROM) Finish Line judge: Gunter Byhan (GER)

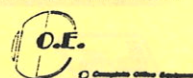
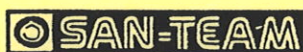



International
Canoe Federation

5th WORLD JUNIOR
CANOE
CHAMPIONSHIPS



29.7. - 1.8. 1993
RAČICE
CZECH REPUBLIC



Czech Canoe
Union

VÝSLEDKOVÁ LISTINA / RESULT LIST

Datum/date 31.7.93

K1M 500 m

Junioren

Závod
Race

92

Mezijízda/Semifinal 2

Cas/Time 08:42

			250 m	Total
1	HUN (5)	320 Bauer Marton	52.07 (4) 01.15	1:45.30
2	BEL (7)	45 Plomteux Laurens	50.92 (1)	1:46.33 01.03
3	SVK (8)	655 Simocko Radovan	52.78 (6) 01.86	1:46.39 01.09
4	POL (4)	515 Porowski Wlodzimierz	51.13 (2) 00.21	1:46.64 01.34
5	SWE (3)	684 Oscarsson Mattias	52.29 (5) 01.37	1:47.46 02.16
6	CZE (9)	159 Vanicek Vit	51.74 (3) 00.82	1:47.85 02.55
7	LAT (1)	412 Zalupe Kristaps	53.22 (7) 02.30	1:48.90 03.60
8	KAZ (6)	776 Egorov Evgenij	53.83 (9) 02.91	1:49.79 04.49
9	POR (2)	538 Sousa Jose	53.50 (8) 02.58	1:58.12 12.82

1-4+the best 5th ->F rest ->out

Temperatur: -water 22 °C -air 21 °C Wind: 0.5m/sec 180°

Chief Official: John Leukemans (BEL)
Starters: Otto Tomiuc (ROM)

Course Umpires: Horvath (HUN) Chielewska (POL)
Finish Line judge: Gunter Byhan (GER)

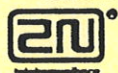

COMPUTER SYSTEMS

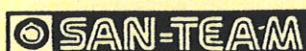



International
Canoe Federation

5th WORLD JUNIOR
CANOE
CHAMPIONSHIPS



29.7. - 1.8. 1993
RAČICE
CZECH REPUBLIC



Czech Canoe
Union

VÝSLEDKOVÁ LISTINA / RESULT LIST

Datum/date 31.7.1993

Závod
Race **93**

NO RACE





International
Canoe Federation

5th WORLD JUNIOR
CANOE
CHAMPIONSHIPS



29.7. - 1.8. 1993
RACICE
CZECH REPUBLIC



Czech Canoe
Union

VÝSLEDKOVÁ LISTINA / RESULT LIST

Datum/date 31.7.93

C1M 500 m

Junioren

Závod

94

Mezijízda/Semifinal 1

Cas/Time 09:00

Race

			250 m	Total
1	CRO (4)	123 Funtak Drazen	59.05 (4) 01.49	1:58.50
2	HUN (5)	319 Balgovits Gabor	59.98 (7) 02.42	1:58.97 00.47
3	CAN (2)	107 Buday Tamas	59.65 (6) 02.09	2:00.78 02.28
4	BLR (3)	66 Zhookovskij Dmitrij	57.56 (1)	2:00.94 02.44
5	FRA (6)	232 Lavigne Yannick	58.00 (2) 00.44	2:01.10 02.60
6	UKR (8)	712 Litvinenko Alexandr	58.83 (3) 01.27	2:01.33 02.83
7	ITA (9)	356 Bedin Andrea	59.38 (5) 01.82	2:01.95 03.45
8	DEN (7)	178 Scales Carsten	1:00.31 (8) 02.75	2:02.91 04.41
9	GRE (1)	303 Terzithis Teofanis	1:01.52 (9) 03.96	2:07.48 08.98

1-4+the best 5th ->F rest ->out

Temperatur: -water 22 °C -air 23 °C Wind: 0.0m/sec

Chief Official: John Leukemans (BEL) Course Umpires: Janssens (BEL) Navasart (ROM)
Starters: Otto Tomiuc (ROM) Finish Line judge: Gunter Byhan (GER)





International
Canoe Federation

5th WORLD JUNIOR
CANOE
CHAMPIONSHIPS



29.7. - 1.8. 1993
RAČICE
CZECH REPUBLIC



Czech Canoe
Union

VÝSLEDKOVÁ LISTINA / RESULT LIST

Datum/date 31.7.93

C1M 500 m

Junioren

Závod

95

Mezijízda/Semifinal 2

Cas/Time 09:10

Race

			250 m	Total
1	ROM(5)	565 Glavan Marcel	56.74 (1)	1:58.09
2	GER (4)	267 Gille Christian	58.28 (4) 01.54	1:58.94 00.85
3	LAT (6)	408 Klava Ainars	57.68 (2) 00.94	1:59.50 01.41
4	BUL (2)	89 Petrov Genaedi	1:00.37 (7) 03.63	2:00.22 02.13
5	ESP (3)	207 Villar Jesus	58.77 (5) 02.03	2:00.31 02.22
6	RUS (7)	602 Gherasiov Victor	58.06 (3) 01.32	2:01.34 03.25
7	SVK (8)	654 Pales Andrej	59.93 (6) 03.19	2:03.15 05.06
8	POL (1)	508 Kondracki Edward	1:00.59 (8) 03.85	2:03.90 05.81
9	MEX(9)	443 Castaneda Jose Luis	1:01.36 (9) 04.62	2:04.22 06.13

1-4+the best 5th ->F rest ->out

Temperatur: -water 22 °C -air 23 °C Wind: 0.0m/sec

Chief Official: John Leukemans (BEL) Course Umpires: Horvath (HUN) Chielewska (POL)
Starters: Otto Tomiuc (ROM) Finish Line judge: Gunter Byhan (GER)

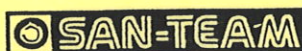



International
Canoe Federation

5th WORLD JUNIOR
CANOE
CHAMPIONSHIPS



29.7. - 1.8. 1993
RAČICE
CZECH REPUBLIC



Czech Canoe
Union

VÝSLEDKOVÁ LISTINA / RESULT LIST

Datum/date 31.7.93

K1W 500 m

Junioren

Závod

96

Mezijízda/Semifinal 1

Cas/Time 09:20

Race

		250 m	Total
1	GER (5) 262 Mucke Manuela	57.06 (1)	1:58.36
2	POL (7) 505 Slota Karolina	57.45 (2) 00.39	1:59.22 00.86
3	CZE (6) 134 Hlucha Katerina	58.27 (3) 01.21	1:59.55 01.19
4	SVK (4) 644 Medovcikova Kristina	1:00.14 (6) 03.08	2:00.24 01.88
5	HUN (2) 311 Bankuti Judit	58.77 (4) 01.71	2:00.81 02.45
6	CAN (9) 103 Mckenzie Laura	59.32 (5) 02.26	2:03.50 05.14
7	MLD(8) 461 Nenno Anna	1:00.58 (7) 03.52	2:03.78 05.42
8	UKR (3) 702 Kovalenko Anna	1:00.96 (8) 03.90	2:06.19 07.83
9	JPN (1) 373 Sayuri Maruyama	1:02.72 (9) 05.66	2:06.27 07.91

1-4+the best 5th ->F rest ->out

Temperatur: -water 22 °C -air 23 °C Wind: 0.5m/sec 90°

Chief Official: John Leukemans (BEL) Course Umpires: Amper D. (ISR) Bland P. (GBR)
Starters: Otto Tomiuc (ROM) Finish Line judge: Gunter Byhan (GER)





International
Canoe Federation

5th WORLD JUNIOR
CANOE
CHAMPIONSHIPS



29.7. - 1.8. 1993
RAČICE
CZECH REPUBLIC



Czech Canoe
Union

VÝSLEDKOVÁ LISTINA / RESULT LIST

Datum/date 31.7.93

K1W 500 m

Junioren

Mezijízda/Semifinal 2

Cas/Time 09:32

Závod
Race

97

		250 m	Total
1	ROM(4) 553 Ionita Racula	57.34 (1)	1:57.35
2	SWE (7) 673 Karlsson Anna	57.89 (2) 00.55	1:59.63 02.28
3	ESP (3) 191 Aramburu Izaskum	58.77 (4) 01.43	1:59.75 02.40
4	ISR (2) 341 Carmi Lior	59.65 (5) 02.31	2:00.49 03.14
5	BLR (5) 51 Bet Elena	58.11 (3) 00.77	2:01.13 03.78
6	USA (8) 732 Beyer Tara	1:00.12 (7) 02.78	2:01.40 04.05
7	BUL (6) 81 Zamfirova Nely	59.92 (6) 02.58	2:02.69 05.34
8	GBR (9) 245 Hemmings Anna	1:00.26 (8) 02.92	2:02.82 05.47
9	ARG (1) 1 Donadio Valeria	1:01.57 (9) 04.23	2:04.75 07.40

1-4+the best 5th ->F rest ->out

Temperatur: -water 22 °C -air 25 °C Wind: 1.4m/sec 180°

Chief Official: John Leukemans (BEL)

Course Umpires: Janssens (BEL) Navasart (ROM)

Starters: Otto Tomiuc (ROM)

Finish Line judge: Gunter Byhan (GER)



COMPUTER SYSTEMS





International
Canoe Federation

5th WORLD JUNIOR
CANOE
CHAMPIONSHIPS



29.7. - 1.8. 1993
RACICE
CZECH REPUBLIC



Czech Canoe
Union

VÝSLEDKOVÁ LISTINA / RESULT LIST

Datum/date 31.7.93

K2M 500 m Junioren Závod/Race **98**
Mezijízda/Semifinal 1 Cas/Time 9:40

			250 m	Total
1	HUN (4)	318 Almasi Peter 334 Szabo Roland	45.26 (1)	1:35.67
2	BUL (5)	85 Karadjov Petar 86 Merkov Petar	46.63 (2) 01.37	1:35.80 00.13
3	ESP (3)	201 Gonzales Jovino 204 Merchan Emilio	47.24 (4) 01.98	1:37.03 01.36
4	BEL (6)	45 Plomteux Laurens 47 Stevens David	48.06 (5) 02.80	1:38.15 02.48
5	NOR (1)	487 Gjeroe Andreas 488 Rudolfsen Frooe	47.07 (3) 01.81	1:38.96 03.29
6	RSA (2)	581 Caldwell Stuart 582 Du Toit Sakkie	49.76 (7) 04.50	1:39.18 03.51
7	LTU (7)	424 Gerulskis Edmundas 422 Balciunas Egidijus	49.54 (6) 04.28	1:39.84 04.17
8	AUT (8)	32 Hinterhofer Martin 33 Stollnberger Markus	51.80 (9) 06.54	1:41.53 05.86
9	USA (9)	738 Mowat Kai 736 Farnum Jim	50.64 (8) 05.38	1:41.60 05.93

1-3 ->F rest ->out

Temperatur: -water °C -air °C Wind: m/sec

Chief Official: John Leukemans (BEL) Course Umpires: Horvath (HUN) Chielewska (POL)
Starters: Otto Tomiuc (ROM) Finish Line judge: Gunter Byhan (GER)

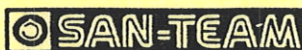



International
Canoe Federation

5th WORLD JUNIOR
CANOE
CHAMPIONSHIPS



29.7. - 1.8. 1993
RAČICE
CZECH REPUBLIC



VÝSLEDKOVÁ LISTINA / RESULT LIST

Datum/date 31.7.93

K2M 500 m

Junioren

Mezijízda/Semifinal 2

Cas/Time 09:49

Závod
Race **99**

		250 m	Total
1	BLR (5) 56 Borisik Piotr 63 Povalanskij Valerij	45.81 (1)	1:34.55
2	GER (4) 272 Lehnert Sven 277 Schmiech Daniel	46.13 (2) 00.32	1:34.79 00.24
3	SVK (6) 651 Kuzel Rastislav 655 Simocko Radovan	48.00 (5) 02.19	1:35.26 00.71
4	POL (2) 507 Aleksandrowicz W. 511 Markiewicz Jaroslaw	46.96 (4) 01.15	1:36.01 01.46
5	RUS (7) 597 Andin Nikolaj 603 Kablov Oleg	46.63 (3) 00.82	1:37.28 02.73
6	SUI (8) 662 Rohr Mathias 661 Bachmann Adrian	49.05 (6) 03.24	1:39.39 04.84
7	KOR (9) 394 Kim Yong Kyo 395 Lee Kyung Soo	49.71 (7) 03.90	1:42.64 08.09
8	DEN (3) 176 Olsen Rene 175 Korshin Andre	50.03 (8) 04.22	1:44.32 09.77
9	POR (1) 539 Varela Sergio 533 Almeida Carlos	51.46 (9) 05.65	1:56.07 21.52

1-3 ->F rest ->out

Temperatur: -water 22 °C -air 25 °C Wind: 2.8m/sec 180°

Chief Official: John Leukemans (BEL)

Course Umpires: Amper D. (ISR) Bland P. (GBR)

Starters: Otto Tomiuc (ROM)

Finish Line judge: Gunter Byhan (GER)





International
Canoe Federation

5th WORLD JUNIOR
CANOE
CHAMPIONSHIPS



29.7. - 1.8. 1993
RACICE
CZECH REPUBLIC



Czech Canoe
Union

VÝSLEDKOVÁ LISTINA / RESULT LIST

Datum/date 31.7.93

K2M 500 m Junioren Závod/Race **100**
Mezijízda/Semifinal 3 Cas/Time 09:59

			250 m	Total
1	LAT (6)	404 Balabolins Kaspars 406 Buncis Edgars	45.64 (1)	1:34.92
2	ROM(2)	571 Sirbu Marian 562 Condache Mihail	46.36 (2) 00.72	1:35.98 01.06
3	CZE (3)	153 Sarka Jan 141 Hejda Premysl	47.29 (4) 01.65	1:36.63 01.71
4	SWE (5)	682 Nilsson Henrik 683 Oscarsson Markus	47.79 (5) 02.15	1:37.27 02.35
5	FRA (7)	238 Vossion Damien 231 Huguet Cyril	49.27 (7) 03.63	1:37.56 02.64
6	ITA (4)	361 Majocchi Jacopo 362 Mangani Flavio	47.07 (3) 01.43	1:37.86 02.94
7	UKR (8)	716 Tchernenko Serguei 713 Navitnyi Oleg	48.28 (6) 02.64	1:39.52 04.60
8	CAN (9)	116 Smith Dave 109 Illsley Scott	51.25 (9) 05.61	1:40.94 06.02
9	TKM(1)	693 Chevtchouk Alexandre 692 Provotorov Dmitri	51.03 (8) 05.39	1:42.36 07.44

1-3 ->F rest ->out

Temperatur: -water 22 °C -air 25 °C Wind: 1.1m/sec 150°

Chief Official: John Leukemans (BEL) Course Umpires: Janssens (BEL) Navasart (ROM)
Starters: Otto Tomiuc (ROM) Finish Line judge: Gunter Byhan (GER)

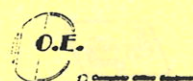



International
Canoe Federation

5th WORLD JUNIOR
CANOE
CHAMPIONSHIPS



29.7. - 1.8. 1993
RAČICE
CZECH REPUBLIC



Czech Canoe
Union

VÝSLEDKOVÁ LISTINA / RESULT LIST

Datum/date 31.7.93

C2M 500 m

Junioren

Mezijízda/Semifinal 1

Cas/Time 10:10

Závod
Race **101**

				250 m	Total
1	BUL (5)	88 Nikolov Rumen 82 Angelov Atanas		50.59 (1)	1:45.97
2	ROM(4)	565 Glavan Marcel 566 Grigore Sami		51.96 (2) 01.37	1:46.75 00.78
3	POL (8)	512 Midloch Pawel 513 Midloch Piotr		52.73 (4) 02.14	1:47.29 01.32
4	RUS (7)	605 Kovalyov Alexandr 606 Kruzshilin Oleg		53.17 (5) 02.58	1:48.12 02.15
5	GER (6)	270 Hesse Jan 281 Zeisner Daniel		53.50 (6) 02.91	1:48.16 02.19
6	BLR (3)	60 Kirilenko Victor 68 Zujev Vitalij		52.29 (3) 01.70	1:48.70 02.73
7	MEX(2)	443 Castaneda Jose Luis 442 Castaneda Benjamin		55.92 (7) 05.33	1:57.04 11.07
8	POR (1)	535 Oliveira Rui 536 Reis Helio		57.01 (8) 06.42	1:57.21 11.24
9	LTU (9)	430 Polomosnov Andrej 427 Medvedev Konstantin		57.34 (9) 06.75	1:57.98 12.01

1-4+the best 5th ->F rest ->out

Temperatur: -water 22 °C -air 26 °C Wind: 2.1m/sec 180°

Chief Official: John Leukemans (BEL)

Course Umpires: Horvath (HUN) Chielewska (POL)

Starters: Otto Tomiuc (ROM)

Finish Line judge: Gunter Byhan (GER)



VÝSLEDKOVÁ LISTINA / RESULT LIST

Datum/date 31.7.93

C2M 500 m Junioren Závod Race **102**
Mezijízda/Semifinal 2 Cas/Time 10:19

			250 m	Total
1	ESP (6)	207 Villar Jesus 206 Perez Gustavo	52.79 (2) 00.28	1:48.44
2	HUN (5)	324 Gyore Attila 322 Csikos Gergely	52.51 (1)	1:48.58 00.14
3	UKR (4)	717 Tchounyak Alexandr 710 Kovaltchouk Andrei	53.61 (5) 01.10	1:48.85 00.41
4	CZE (2)	156 Sterba Petr 147 Kozelsky David	53.34 (4) 00.83	1:49.70 01.26
5	LAT (7)	409 Kovalovs Sergejs 410 Lagzdins Valentins	53.01 (3) 00.50	1:50.78 02.34
6	GBR (8)	248 Crowther Stuart 253 Lane Malcolm	54.71 (6) 02.20	1:52.51 04.07
7	FRA (3)	233 Moreaux Denis 234 Normand Samuel	54.98 (7) 02.47	1:53.85 05.41
8	USA (1)	737 Johnson Nate 735 Batlik Vaclav	57.07 (8) 04.56	1:58.69 10.25
9	JPN (9)	375 Eiji Uejyo 386 Yoshimi Hosotani	58.83 (9) 06.32	1:59.63 11.19

1-4+the best 5th ->F rest ->out

Temperatur: -water 22 °C -air 26 °C Wind: 2.2m/sec 180°

Chief Official: John Leukemans (BEL) Course Umpires: Amper D. (ISR) Bland P. (GBR)
Starters: Otto Tomiuc (ROM) Finish Line judge: Gunter Byhan (GER)



International
Canoe Federation

5th WORLD JUNIOR
CANOE
CHAMPIONSHIPS



29.7. - 1.8. 1993
RAČICE
CZECH REPUBLIC



Czech Canoe
Union

VÝSLEDKOVÁ LISTINA / RESULT LIST

Datum/date 31.7.93

K2W 500 m

Junioren

Závod
Race **103**

Mezijízda/Semifinal 1

Cas/Time 10:29

			250 m	Total
1	ROM(8)	553 Ionita Racula 555 Pirvu Carmen	53.11 (4) 00.98	1:47.17
2	HUN(4)	314 Kovacs Katalin 312 Barocsi Andrea	52.40 (2) 00.27	1:47.74 00.57
3	UKR(5)	704 Tchaytchouk Alevtina 701 Duknanina Elena	52.13 (1)	1:49.36 02.19
4	POL(6)	504 Pastuszka Aneta 503 Opara Monika	52.73 (3) 00.60	1:49.54 02.37
5	GBR(9)	242 Fowler Suzanne 243 Giles Rebecca	54.93 (7) 02.80	1:49.65 02.48
6	SWE(7)	674 Karlsson Therese 673 Karlsson Anna	53.61 (6) 01.48	1:49.78 02.61
7	CAN(3)	105 Prince Karina 101 Furneaux Karen	53.28 (5) 01.15	1:50.04 02.87
8	ITA(2)	351 Pedrazzi Silvia 352 Pellegrini Ilenia	56.19 (8) 04.06	1:52.55 05.38
9	USA(1)	732 Beyer Tara 734 White Olivia	56.46 (9) 04.33	1:54.36 07.19

1-4+the best 5th ->F rest ->out

Temperatur: -water 22 °C -air 26 °C Wind: 3.2m/sec 200°

Chief Official: John Leukemans (BEL)
Starters: Otto Tomiuc (ROM)

Course Umpires: Janssens (BEL) Navasart (ROM)
Finish Line judge: Gunter Byhan (GER)



COMPUTER SYSTEMS

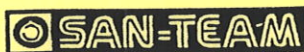



International
Canoe Federation

5th WORLD JUNIOR
CANOE
CHAMPIONSHIPS



29.7. - 1.8. 1993
RACICE
CZECH REPUBLIC



Czech Canoe
Union

VÝSLEDKOVÁ LISTINA / RESULT LIST

Datum/date 31.7.93

K2W 500 m Junioren

Mezijízda/Semifinal 2

Cas/Time 10:39

Závod
Race **104**

			250 m	Total
1	GER (5)	262 Mucke Manuela 263 Muller Heike	50.91 (2) 00.49	1:45.96
2	ESP (3)	193 Iglesias Andrea 195 Romero Antonia	50.42 (1)	1:46.44 00.48
3	BLR (6)	51 Bet Elena 52 Maslova Natalia	53.17 (4) 02.75	1:47.58 01.62
4	SVK (8)	642 Hochschornerov Eva 641 Birvonova Miriam	52.07 (3) 01.65	1:47.59 01.63
5	CZE (7)	131 Borkovcova Sarka 133 Hekova Katerina	54.04 (6) 03.62	1:48.86 02.90
6	FRA (9)	223 Clet Cecile 226 Metenier Linda	54.70 (8) 04.28	1:49.62 03.66
7	KAZ (1)	772 Parfjonova Elena 773 Muravjova Natalja	53.39 (5) 02.97	1:49.88 03.92
8	RUS (4)	592 Kononova Yuliya 593 Minayeva Marina	54.28 (7) 03.86	1:51.25 05.29
9	NOR (2)	483 Halano May Lise 484 Knuosen Christine	55.20 (9) 04.78	1:51.34 05.38

1-4+the best 5th ->F rest ->out

Temperatur: -water 22 °C -air 26 °C Wind: 2.8m/sec 180°

Chief Official: John Leukemans (BEL) Course Umpires: Horvath (HUN) Chielewska (POL)
Starters: Otto Tomiuc (ROM) Finish Line judge: Gunter Byhan (GER)





International
Canoe Federation

5th WORLD JUNIOR
CANOE
CHAMPIONSHIPS



29.7. - 1.8. 1993
RAČICE
CZECH REPUBLIC



Czech Canoe
Union

VÝSLEDKOVÁ LISTINA / RESULT LIST

Datum/date 31.7.93

K4M 500 m

Junioren

Mezijízda/Semifinal 1

Cas/Time 10:51

Závod
Race **105**

			250 m	Total
1	HUN (4)	332 Storz Akos 327 Kovacs Akos 333 Storz Botond 317 Acs Tamas	41.74 (1)	1:25.35
2	SVK (7)	649 Kasuba Lucian 647 Brodsky Ladislav 650 Kiss Roman 656 Straka Peter	43.72 (6) 01.98	1:27.49 02.14
3	ROM(1)	558 Andrei Mihaita 560 Baban Marian 564 Enache Mihail 567 Hanches Ioan	42.40 (2) 00.66	1:27.93 02.58
4	POR (2)	539 Varela Sergio 534 Fazenda Diogo 538 Sousa Jose 533 Almeida Carlos	42.62 (3) 00.88	1:28.40 03.05
4	POL (5)	510 Lorenz Tomasz 518 Wolff Pawel 520 Zurek Ireneusz 509 Lakomy Pawel	43.61 (5) 01.87	1:28.40 03.05
6	FRA (3)	237 Robert Yann 229 Bocage Etienne 236 Richard Alban 235 Rebours Loic	43.17 (4) 01.43	1:28.47 03.12
7	ITA (8)	357 Blasi Andrea 366 Favalli Simone 368 Nardelli Ciro 363 Mate Davide	44.71 (8) 02.97	1:29.30 03.95
8	DEN (9)	172 Eilert Michael 177 Rasmussen Brian 179 Svenningen Claus 174 Heering Nicolai	45.59 (9) 03.85	1:30.16 04.81
9	BLR (6)	56 Borisik Piotr 63 Povalanskij Valerij 57 Degtiariov Vladislav 64 Rubanov Gennadij	44.27 (7) 02.53	1:36.26 10.91

1-4+the best 5th ->F rest ->out

Temperatur: -water 22 °C -air 25 °C Wind: 4.1m/sec 210°

Chief Official: John Leukemans (BEL)

Course Umpires: Amper D. (ISR) Bland P. (GBR)

Starters: Otto Tomiuc (ROM)

Finish Line judge: Gunter Byhan (GER)





International
Canoe Federation

5th WORLD JUNIOR
CANOE
CHAMPIONSHIPS



29.7. - 1.8. 1993
RACICE
CZECH REPUBLIC



VÝSLEDKOVÁ LISTINA / RESULT LIST

Datum/date 31.7.93

K4M 500 m

Junioren

Závod
Race **106**

Mezijízda/Semifinal 2

Cas/Time 11:00

				250 m	Total
1	GER (4)	268 Goedicke Robert 269 Heck Jens 276 Ruhl Marco 277 Schmiech Daniel		41.30 (1)	1:25.41
2	RUS (5)	600 Chertov Oleg 612 Tissin Andrei 597 Andin Nikolaj 610 Mironyuk Andrej		41.63 (2) 00.33	1:26.01 00.60
3	ESP (6)	202 Leal Carlos 198 Cuinas Antonio 200 Garcia Carlos 197 Busto Manuel		42.07 (3) 00.77	1:26.59 01.18
4	CZE (7)	153 Sarka Jan 141 Hejda Premysl 157 Termer Vlastimil 158 Tonder Tomas		43.83 (6) 02.53	1:27.90 02.49
5	SWE (8)	682 Nilsson Henrik 681 Myrman Royne 680 Haglund Hans 678 Berglund Mats		43.23 (4) 01.93	1:28.51 03.10
6	NOR (1)	489 Sigurosen Stian 486 Fjeloheim Nils Olav 487 Gjeroe Andreas 488 Rudolfsen Frooe		43.50 (5) 02.20	1:29.49 04.08
7	ARG (2)	7 Suaya Pablo 3 Basualto Ariel 4 Canepa Diego 5 Correa Javier		45.20 (9) 03.90	1:30.67 05.26
8	RSA (3)	585 Stenhouse Matthew 586 Willis Russell 583 Leonard Danie 584 Schoeman Stephan		44.22 (7) 02.92	1:30.70 05.29
9	FIN (9)	792 Keso Mikko 793 Ruokonen Riku 794 Winqvist Simon 795 Mikkonen Kalle		44.65 (8) 03.35	1:31.02 05.61

1-4+the best 5th ->F rest ->out

Temperatur: -water 22 °C -air 26 °C Wind: 5.0m/sec 180°

Chief Official: John Leukemans (BEL) Course Umpires: Janssens (BEL) Navasart (ROM)
Starters: Otto Tomiuc (ROM) Finish Line judge: Gunter Byhan (GER)





International
Canoe Federation

5th WORLD JUNIOR
CANOE
CHAMPIONSHIPS



29.7. - 1.8. 1993
RACICE
CZECH REPUBLIC



Czech Canoe
Union

VÝSLEDKOVÁ LISTINA / RESULT LIST

Datum/date 31.7.93

C4M 500 m

Junioren

Závod

107

Mezijízda/Semifinal 1

Cas/Time 11:10

Race

			250 m	Total
1	RUS (3)	605 Kovalyov Alexandr 602 Gherasiov Victor 601 Elizarov Maxim 606 Kruzshilin Oleg	48.39 (1)	1:39.47
2	CZE (4)	149 Marisko Jan 137 Brecka Jan 142 Juttner Tomas 148 Machac Jan	49.65 (3) 01.26	1:40.70 01.23
3	FRA (5)	230 Ethuin David 232 Lavigne Yannick 227 Assa Martin 228 Barbey Laurent	49.54 (2) 01.15	1:40.86 01.39
4	LTU (6)	429 Paulauskas Dainius 427 Medvedev Konstantin 430 Polomosnov Andrej 426 Jonkus Mindaugas	52.12 (4) 03.73	1:51.11 11.64
5	JPN (2)	375 Eiji Uejyo 386 Yoshimi Hosotani 377 Hiroyuki Sato 380 Kiyoshige Saito	54.54 (5) 06.15	1:54.31 14.84

1-2+the best 3rd ->F rest ->out

Temperatur: -water 22 °C -air 26 °C Wind: 4.1m/sec 180°

Chief Official: John Leukemans (BEL) Course Umpires: Horvath (HUN) Chielewska (POL)
Starters: Otto Tomiuc (ROM) Finish Line judge: Gunter Byhan (GER)

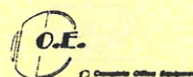
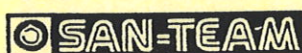



International
Canoe Federation

5th WORLD JUNIOR
CANOE
CHAMPIONSHIPS



29.7. - 1.8. 1993
RACICE
CZECH REPUBLIC



Czech Canoe
Union

VÝSLEDKOVÁ LISTINA / RESULT LIST

Datum/date 31.7.93

C4M 500 m

Junioren

Mezijízda/Semifinal 2

Cas/Time 11:19

Závod
Race **108**

		250 m	Total
1	POL (4) 519 Zajaczkowski Slawomir 517 Watkowski Norbert 512 Midloch Pawel 513 Midloch Piotr	48.94 (2) 00.38	1:39.94
2	GRE (3) 305 Zachos Lukas 303 Terzithis Teofanis 294 Arapis Athanasios 297 Kiriazis Dimitrious	48.56 (1)	1:40.20 00.26
3	ITA (2) 367 Ventriglia Alessandro 364 Nardi Claudio 356 Bedin Andrea 358 Bonacina Antonio	51.19 (3) 02.63	1:41.63 01.69
4	BLR (5) 68 Zujev Vitalij 66 Zhookovskij Dmitrij 62 Markosian Mikhail 60 Kirilenko Victor	51.30 (4) 02.74	1:44.40 04.46

1-2+the best 3rd ->F rest ->out

Temperatur: -water 22 °C -air 26 °C Wind: 4.1m/sec 180°

Chief Official: John Leukemans (BEL) Course Umpires: Amper D. (ISR) Bland P. (GBR)
Starters: Otto Tomiuc (ROM) Finish Line judge: Gunter Byhan (GER)



© Complete Office Equipment





International
Canoe Federation

5th WORLD JUNIOR
CANOE
CHAMPIONSHIPS



29.7. - 1.8. 1993
RAČICE
CZECH REPUBLIC



Czech Canoe
Union

VÝSLEDKOVÁ LISTINA / RESULT LIST

Datum/date 31.7.93

K1M 500 m

Junioren

Finále/Final

Cas/Time 15:31

Závod
Race **109**

			250 m	Total
1	BLR (5)	57 Degtiariov Vladislav	49.59 (1)	1:42.51
2	HUN (4)	320 Bauer Marton	50.20 (3) 00.61	1:43.14 00.63
3	ESP (8)	202 Leal Carlos	51.30 (6) 01.71	1:43.34 00.83
4	GER (7)	279 Ulm Stefan	50.64 (4) 01.05	1:43.99 01.48
5	AUS (6)	20 Evans Peter	49.87 (2) 00.28	1:44.28 01.77
6	BEL (3)	45 Plomteux Laurens	50.91 (5) 01.32	1:45.17 02.66
7	FRA (9)	237 Robert Yann	52.29 (9) 02.70	1:46.75 04.24
8	SVK (2)	655 Simocko Radovan	51.52 (7) 01.93	1:46.94 04.43
9	POL (1)	515 Porowski Wlodzimierz	51.96 (8) 02.37	1:48.49 05.98

Temperatur: -water 23 °C -air 22 °C Wind: 3.2m/sec 240°

Chief Official: John Leukemans (BEL)
Starters: Otto Tomiuc (ROM)

Course Umpires: Janssens (BEL) Navasart (ROM)
Finish Line judge: Gunter Byhan (GER)



Complete Office Equipment





International
Canoe Federation

5th WORLD JUNIOR
CANOE
CHAMPIONSHIPS



29.7. - 1.8. 1993
RACICE
CZECH REPUBLIC



VÝSLEDKOVÁ LISTINA / RESULT LIST

Datum/date 31.7.93

C1M 500 m

Junioren

Závod
Race **110**

Finále/Final

Cas/Time 15:50

			250 m	Total
1	ROM(4)	565 Glavan Marcel	56.13 (2) 00.22	1:55.83
2	GER (3)	267 Gille Christian	55.91 (1)	1:55.88 00.05
3	CRO (5)	123 Funtak Drazen	57.17 (3) 01.26	1:56.78 00.95
4	HUN(6)	319 Balgovits Gabor	1:00.09 (9) 04.18	1:57.51 01.68
5	ESP (9)	207 Villar Jesus	57.39 (4) 01.48	1:57.97 02.14
6	BLR (8)	66 Zhookovskij Dmitrij	57.78 (5) 01.87	1:58.76 02.93
7	BUL (1)	89 Petrov Genaedi	59.70 (8) 03.79	2:00.10 04.27
8	CAN (7)	107 Buday Tamas	58.93 (7) 03.02	2:00.13 04.30
9	LAT (2)	408 Klava Ainars	58.27 (6) 02.36	2:01.82 05.99

Temperatur: -water 22 °C -air 23 °C Wind: 3.0m/sec 200°

Chief Official: John Leukemans (BEL) Course Umpires: Horvath (HUN) Chielewska (POL)
Starters: Otto Tomiuc (ROM) Finish Line judge: Gunter Byhan (GER)





International
Canoe Federation

5th WORLD JUNIOR
CANOE
CHAMPIONSHIPS



29.7. - 1.8. 1993
RAČICE
CZECH REPUBLIC



VÝSLEDKOVÁ LISTINA / RESULT LIST

Datum/date 31.7.93

K1W 500 m

Junioren

Finále/Final

Cas/Time 16:09

Závod
Race **111**

			250 m	Total
1	GER (5)	262 Mucke Manuela	55.86 (1)	1:56.34
2	CZE (7)	134 Hlucha Katerina	56.90 (4) 01.04	1:57.38 01.04
3	POL (6)	505 Slota Karolina	56.62 (3) 00.76	1:58.61 02.27
4	SVK (8)	644 Medovcikova Kristina	59.04 (7) 03.18	1:59.84 03.50
5	HUN (9)	311 Bankuti Judit	57.12 (5) 01.26	2:00.05 03.71
6	ROM(4)	553 Ionita Racula	56.40 (2) 00.54	2:00.12 03.78
7	SWE (3)	673 Karlsson Anna	58.66 (6) 02.80	2:00.60 04.26
8	ESP (2)	191 Aramburu Izaskum	1:01.02 (8) 05.16	2:00.83 04.49
9	ISR (1)	341 Carmi Lior	1:02.28 (9) 06.42	2:04.58 08.24

Temperatur: -water 22 °C -air 24 °C Wind: 0.4 m/sec 180°

Chief Official: John Leukemans (BEL)

Course Umpires: Amper D. (ISR) Bland P. (GBR)

Starters: Otto Tomiuc (ROM)

Finish Line judge: Gunter Byhan (GER)



COMPUTER SYSTEMS



© Complete Office Equipment





International
Canoe Federation

5th WORLD JUNIOR
CANOE
CHAMPIONSHIPS



29.7. - 1.8. 1993
RAČICE
CZECH REPUBLIC



VÝSLEDKOVÁ LISTINA / RESULT LIST

Datum/date 31.7.93

K2M 500 m

Juniořen

Závod
Race **112**

Finále/Final

Cas/Time 16:33

			250 m	Total
1	GER (7)	272 Lehnert Sven 277 Schmiech Daniel	46.52 (3) 01.09	1:35.29
2	HUN (5)	318 Almasi Peter 334 Szabo Roland	45.59 (2) 00.16	1:35.69 00.40
3	LAT (6)	404 Balabolins Kaspars 406 Buncis Edgars	46.96 (5) 01.53	1:37.13 01.84
4	BLR (4)	56 Borisik Piotr 63 Povalanskij Valerij	45.43 (1)	1:37.32 02.03
5	SVK (1)	651 Kuzel Rastislav 655 Simocko Radovan	49.05 (9) 03.62	1:37.33 02.04
6	ESP (8)	201 Gonzales Jovino 204 Merchan Emilio	46.74 (4) 01.31	1:37.90 02.61
7	BUL (3)	85 Karadjov Petar 86 Merkov Petar	47.51 (7) 02.08	1:38.40 03.11
8	ROM(2)	571 Sirbu Marian 562 Condrache Mihail	47.73 (8) 02.30	1:38.42 03.13
9	CZE (9)	153 Sarka Jan 141 Hejda Premysl	47.24 (6) 01.81	1:38.76 03.47

Temperatur: -water 22 °C -air 24 °C Wind: 0.6m/sec 170°

Chief Official: John Leukemans (BEL)

Course Umpires: Janssens (BEL) Navasart (ROM)

Starters: Otto Tomiuc (ROM)

Finish Line judge: Gunter Byhan (GER)





International
Canoe Federation

5th WORLD JUNIOR
CANOE
CHAMPIONSHIPS



29.7. - 1.8. 1993
RACICE
CZECH REPUBLIC



Czech Canoe
Union

VÝSLEDKOVÁ LISTINA / RESULT LIST

Datum/date 31.7.93

C2M 500 m

Junioren

Finále/Final

Čas/Time 16:50

Závod
Race **113**

		250 m	Total
1	BUL (5) 88 Nikolov Rumén 82 Angelov Atanas	51.08 (1)	1:46.98
2	HUN (3) 324 Györe Attila 322 Csikos Gergely	51.57 (2) 00.49	1:47.56 00.58
3	ROM (6) 565 Glavan Marcel 566 Grigore Sami	52.23 (3) 01.15	1:48.06 01.08
4	ESP (4) 207 Villar Jesús 206 Perez Gustavo	53.05 (5) 01.97	1:49.50 02.52
5	RUS (8) 605 Kovalyov Alexandr 606 Kruzshilin Oleg	52.39 (4) 01.31	1:49.89 02.91
6	GER (9) 270 Hesse Jan 281 Zeisner Daniel	53.77 (7) 02.69	1:49.92 02.94
7	POL (7) 512 Midloch Pawel 513 Midloch Piotr	54.26 (8) 03.18	1:51.20 04.22
8	UKR (2) 717 Tchounyak Alexandr 710 Kovaltchouk Andrei	55.09 (9) 04.01	1:52.34 05.36
9	CZE (1) 156 Sterba Petr 147 Kozelsky David	53.55 (6) 02.47	1:53.09 06.11

Temperatur: -water 22 °C -air 25 °C Wind: 0.4m/sec 120°

Chief Official: John Leukemans (BEL) Course Umpires: Horvath (HUN) Chielewska (POL)
Starters: Otto Tomiuc (ROM) Finish Line judge: Gunter Byhan (GER)



COMPUTER SYSTEMS





International
Canoe Federation

5th WORLD JUNIOR
CANOE
CHAMPIONSHIPS



29.7. - 1.8. 1993
RAČICE
CZECH REPUBLIC



VÝSLEDKOVÁ LISTINA / RESULT LIST

Datum/date 31.7.93

K2W 500 m

Junioren

Závod
Race **114**

Finále/Final

Cas/Time 17:09

		250 m	Total
1	GER (4) 262 Mucke Manuela 263 Muller Heike	51.52 (1)	1:49.04
2	HUN (6) 314 Kovacs Katalin 312 Barocsi Andrea	52.62 (2) 01.10	1:49.96 00.92
3	ESP (3) 193 Iglesias Andrea 195 Romero Antonia	52.90 (3) 01.38	1:51.90 02.86
4	ROM(5) 553 Ionita Racula 555 Pirvu Carmen	54.21 (7) 02.69	1:52.74 03.70
5	POL (8) 504 Pastuszka Aneta 503 Opara Monika	53.94 (6) 02.42	1:52.76 03.72
6	CZE (9) 131 Borkovcova Sarka 133 Hekova Katerina	54.43 (8) 02.91	1:53.33 04.29
7	BLR (2) 51 Bet Elena 52 Maslova Natalia	53.61 (5) 02.09	1:53.46 04.42
8	SVK (1) 642 Hochschornerov Eva 641 Birvonova Miriam	53.23 (4) 01.71	1:53.55 04.51
9	UKR (7) 704 Tchaytchouk Alevtina 701 Duknanina Elena	54.87 (9) 03.35	1:54.37 05.33

Temperatur: -water 22 °C -air 24 °C Wind: 0.5m/sec 210°

Chief Official: John Leukemans (BEL) Course Umpires: Amper D. (ISR) Bland P. (GBR)
Starters: Otto Tomiuc (ROM) Finish Line judge: Gunter Byhan (GER)





International
Canoe Federation

5th WORLD JUNIOR
CANOE
CHAMPIONSHIPS



29.7. - 1.8. 1993
RÁČICE
CZECH REPUBLIC



Czech Canoe
Union

VÝSLEDKOVÁ LISTINA / RESULT LIST

Datum/date 31.7.93

K4M 500 m

Junioren

Závod
Race **115**

Finále/Final

Cas/Time 17:30

			250 m	Total
1	HUN (5)	332 Storz Akos 327 Kovacs Akos 333 Storz Botond 317 Acs Tamas	41.52 (1)	1:25.26
2	GER (4)	268 Goedicke Robert 269 Heck Jens 276 Ruhl Marco 277 Schmiech Daniel	41.85 (2) 00.33	1:27.52 02.26
3	ESP (2)	202 Leal Carlos 198 Cuinas Antonio 200 Garcia Carlos 197 Busto Manuel	43.50 (6) 01.98	1:28.22 02.96
4	SVK (6)	649 Kasuba Lucian 647 Brodsky Ladislav 650 Kiss Roman 656 Straka Peter	44.43 (8) 02.91	1:28.36 03.10
5	RUS (3)	600 Chertov Oleg 612 Tissin Andrei 597 Andin Nikolaj 610 Mironyuk Andrej	43.23 (5) 01.71	1:28.92 03.66
6	POL (9)	510 Lorenz Tomasz 518 Wolff Pawel 520 Zurek Ireneusz 509 Lakomy Pawel	44.27 (7) 02.75	1:29.31 04.05
7	ROM(7)	558 Andrei Mihaita 560 Baban Marian 564 Enache Mihail 567 Hanches Ioan	42.68 (3) 01.16	1:30.68 05.42
8	CZE (1)	153 Sarka Jan 141 Hejda Premysl 157 Termer Vlastimil 158 Tonder Tomas	44.93 (9) 03.41	1:30.95 05.69
9	POR (8)	539 Varela Sergio 534 Fazenda Diogo 538 Sousa Jose 533 Almeida Carlos	42.95 (4) 01.43	1:32.22 06.96

Temperatur: -water 22 °C -air 21 °C Wind: 3.6m/sec 210°

Chief Official: Johh Leukemans (BEL) Course Umpires: Janssens (BEL) Navasart (ROM)
Starters: Otto Tomiuc (ROM) Finish Line judge: Gunter Byhan (GER)



Complete Other Equipment





International
Canoe Federation

5th WORLD JUNIOR
CANOE
CHAMPIONSHIPS



29.7. - 1.8. 1993
RAČICE
CZECH REPUBLIC



VÝSLEDKOVÁ LISTINA / RESULT LIST

Datum/date 31.7.93

C4M 500 m

Junioren

Závod
Race **116**

Finals/Final

Cas/Time 17:50

			250 m	Total
1	BUL (4)	88 Nikolov Rumen 82 Angelov Atanas 83 Atanasov Dimitar 84 Atanasov Stanimir	47.12 (1)	1:37.35
2	UKR (6)	717 Tchounyak Alexandr 710 Kovaltchouk Andrei 708 Dvouljat Serguei 709 Korenyuk Valentin	47.29 (2) 00.17	1:38.09 00.74
3	GER (3)	267 Gille Christian 278 Tiedge Rene 280 Vesely Kay 266 Bebber Ricardo	48.44 (3) 01.32	1:38.71 01.36
4	HUN (5)	335 Telek Gabor 331 Redenzski Antal 328 Kurucz Zoltan 329 Marsalla Viktor	49.76 (5) 02.64	1:38.88 01.53
5	CZE (8)	149 Marisko Jan 137 Brecka Jan 142 Juttner Tomas 148 Machac Jan	48.99 (4) 01.87	1:41.59 04.24
6	POL (2)	519 Zajaczkowski Slawomir 517 Watkowski Norbert 512 Midloch Pawel 513 Midloch Piotr	50.69 (7) 03.57	1:42.90 05.55
7	RUS (7)	605 Kovalyov Alexandr 602 Gherasiov Victor 601 Elizarov Maxim 606 Kruzshilin Oleg	50.42 (6) 03.30	1:43.27 05.92
8	FRA (9)	230 Ethuin David 232 Lavigne Yannick 227 Assa Martin 228 Barbey Laurent	51.41 (9) 04.29	1:43.75 06.40
9	GRE (1)	305 Zachos Lukas 303 Terzithis Teofanis 294 Arapis Athanasios 297 Kiriazis Dimitrious	51.13 (8) 04.01	1:44.61 07.26

Temperatur: -water 22 °C -air 20 °C Wind: 1.4m/sec 130°

Chief Official: John Leukemans (BEL) Course Umpires: Horvath (HUN) Chielewska (POL)
Starters: Otto Tomiuc (ROM) Finish Line judge: Gunter Byhan (GER)



COMPUTER SYSTEMS



Complete Office Equipment





International
Canoe Federation

5th WORLD JUNIOR
CANOE
CHAMPIONSHIPS



29.7. - 1.8. 1993
RAČICE
CZECH REPUBLIC



VÝSLEDKOVÁ LISTINA / RESULT LIST

Datum/date 01.8.93

K1M 1000 m Junioren

Mezijízda/Semifinal 1

Cas/Time 09:01

Závod
Race **117**

			250 m	500 m	750 m	Total
1	GER (5)	279 Ulm Stefan	53.17 (2) 01.26	1:51.17 (2) 00.49	2:48.08 (1)	3:45.43
2	AUS (3)	20 Evans Peter	51.91 (1)	1:50.68 (1)	2:49.12 (3) 01.04	3:46.96 01.53
3	ESP (6)	198 Cuinas Antonio	53.56 (3) 01.65	1:51.56 (3) 00.88	2:48.84 (2) 00.76	3:47.35 01.92
4	SVK (7)	651 Kuzel Rastislav	56.08 (9) 04.17	1:53.81 (5) 03.13	2:50.27 (4) 02.19	3:47.67 02.24
5	ITA (4)	361 Majocchi Jacopo	53.72 (4) 01.81	1:53.42 (4) 02.74	2:50.55 (5) 02.47	3:48.12 02.69
6	FIN (1)	791 Latvamaki Kimmo	55.42 (8) 03.51	1:56.12 (8) 05.44	2:54.17 (8) 06.09	3:50.48 05.05
7	POL (8)	509 Lakomy Pawel	54.21 (5) 02.30	1:55.35 (7) 04.67	2:53.18 (7) 05.10	3:51.69 06.26
8	SWE (2)	682 Nilsson Henrik	54.71 (6) 02.80	1:54.80 (6) 04.12	2:52.74 (6) 04.66	3:52.70 07.27
9	SUI (9)	661 Bachmann Adrian	55.20 (7) 03.29	1:56.26 (9) 05.58	2:58.24 (9) 10.16	3:56.69 11.26

1-4+the best 5th ->F rest ->out

Temperatur: -water 20 °C -air 17 °C Wind: 0.1m/sec 180°

Chief Official: John Leukemans (BEL)

Course Umpires: Amper D. (ISR) Bland P. (GBR)

Starters: Mike Moir (CAN)

Finish Line judge: Gunter Byhan (GER)



COMPUTER SYSTEMS





International
Canoe Federation

5th WORLD JUNIOR
CANOE
CHAMPIONSHIPS



29.7. - 1.8. 1993
RAČICE
CZECH REPUBLIC



Czech Canoe
Union

VÝSLEDKOVÁ LISTINA / RESULT LIST

Datum/date 01.8.93

K1M 1000 m Junioren Závod Race **118**
Mezijízda/Semifinal 2 Cas/Time 09:11

			250 m	500 m	750 m	Total
1	HUN (5)	320 Bauer Marton	55.70 (5) 01.87	1:51.89 (3) 00.66	2:49.78 (3) 00.66	3:46.06
2	BLR (4)	56 Borisik Piotr	53.83 (1)	1:51.23 (1)	2:49.12 (1)	3:46.72 00.66
3	UKR (8)	711 Kutcherenko Serguei	54.98 (3) 01.15	1:51.50 (2) 00.27	2:49.39 (2) 00.27	3:47.12 01.06
4	FRA (3)	231 Huguet Cyril	55.97 (6) 02.14	1:52.65 (4) 01.42	2:51.15 (4) 02.03	3:49.60 03.54
5	DEN (1)	174 Heering Nicolai	54.71 (2) 00.88	1:53.86 (5) 02.63	2:52.69 (5) 03.57	3:49.81 03.75
6	CAN (6)	112 Maksymiuk Daniel	57.23 (8) 03.40	1:55.13 (7) 03.90	2:53.46 (6) 04.34	3:50.93 04.87
7	BEL (7)	47 Stevens David	55.37 (4) 01.54	1:54.30 (6) 03.07	2:53.84 (7) 04.72	3:51.60 05.54
8	RUS (2)	612 Tissin Andrei	56.90 (7) 03.07	1:55.73 (8) 04.50	2:55.87 (8) 06.75	3:53.99 07.93
9	USA (9)	739 Osusky Juraj	59.98 (9) 06.15	1:57.32 (9) 06.09	2:56.81 (9) 07.69	4:00.05 13.99

1-4+the best 5th ->F rest ->out

Temperatur: -water 20 °C -air 17 °C Wind: 0.6m/sec 180°

Chief Official: John Leukemans (BEL) Course Umpires: Janssens (BEL) Navasart (ROM)
Starters: Mike Moir (CAN) Finish Line judge: Gunter Byhan (GER)



COMPUTER SYSTEMS



Complete Office Equipment





International
Canoe Federation

5th WORLD JUNIOR
CANOE
CHAMPIONSHIPS



29.7. - 1.8. 1993
RAČICE
CZECH REPUBLIC



VÝSLEDKOVÁ LISTINA / RESULT LIST

Datum/date 01.8.93

C1M 1000 m Junioren Závod Race **119**
Mezijízda/Semifinal 1 Cas/Time 09:21

			250 m	500 m	750 m	Total
1	HUN (5)	319 Balgovits Gabor	1:03.00 (6) 02.03	2:09.35 (5) 02.14	3:13.94 (3) 00.93	4:16.62
2	CRO (6)	123 Funtak Drazen	1:00.97 (1)	2:07.65 (2) 00.44	3:13.28 (2) 00.27	4:16.73 00.11
3	GER (4)	266 Bebber Ricardo	1:01.13 (2) 00.16	2:07.21 (1)	3:13.01 (1)	4:18.97 02.35
4	LAT (3)	408 Klava Ainars	1:01.46 (3) 00.49	2:08.25 (3) 01.04	3:14.60 (4) 01.59	4:20.38 03.76
5	DEN (8)	178 Scales Carsten	1:03.17 (7) 02.20	2:10.61 (8) 03.40	3:15.81 (6) 02.80	4:20.46 03.84
6	BLR (9)	66 Zhookovskij Dmitrij	1:02.51 (5) 01.54	2:09.02 (4) 01.81	3:15.43 (5) 02.42	4:20.96 04.34
7	CZE (7)	137 Brecka Jan	1:03.55 (8) 02.58	2:10.23 (7) 03.02	3:16.25 (7) 03.24	4:21.55 04.93
8	UKR (2)	708 Dvoulyat Serguei	1:01.63 (4) 00.66	2:09.79 (6) 02.58	3:17.24 (8) 04.23	4:24.63 08.01
9	RUS (1)	607 Lantsayev Vasilij	1:04.43 (9) 03.46	2:12.59 (9) 05.38	3:19.49 (9) 06.48	4:25.24 08.62

1-4+the best 5th ->F rest ->out

Temperatur: -water 20 °C -air 17 °C Wind: 0.0m/sec

Chief Official: John Leukemans (BEL) Course Umpires: Horvath (HUN) Chielewska (POL)
Starters: Mike Moir (CAN) Finish Line judge: Gunter Byhan (GER)





International
Canoe Federation

5th WORLD JUNIOR
CANOE
CHAMPIONSHIPS



29.7. - 1.8. 1993
RAČICE
CZECH REPUBLIC



VÝSLEDKOVÁ LISTINA / RESULT LIST

Datum/date 01.8.93

C1M 1000 m Junioren Závod Race **120**
Mezijízda/Semifinal 2 Cas/Time 09:33

			250 m	500 m	750 m	Total
1	ESP (6)	203 Mascato David	59.32 (1)	2:03.91 (1)	3:09.66 (1)	4:16.87
2	ROM(5)	568 Huidu Florian	59.81 (2) 00.49	2:06.22 (2) 02.31	3:11.91 (2) 02.25	4:18.25 01.38
3	POL (4)	508 Kondracki Edward	1:02.72 (5) 03.40	2:07.86 (4) 03.95	3:13.23 (3) 03.57	4:18.51 01.64
4	CAN (7)	107 Buday Tamas	1:01.62 (3) 02.30	2:07.09 (3) 03.18	3:13.44 (4) 03.78	4:19.98 03.11
5	ITA (3)	356 Bedin Andrea	1:03.00 (6) 03.68	2:09.79 (6) 05.88	3:16.03 (6) 06.37	4:22.92 06.05
6	SVK (8)	654 Pales Andrej	1:02.23 (4) 02.91	2:08.25 (5) 04.34	3:15.81 (5) 06.15	4:27.24 10.37
7	MEX(2)	443 Castaneda Jose Luis	1:04.32 (7) 05.00	2:11.87 (7) 07.96	3:20.70 (7) 11.04	4:29.55 12.68
8	GBR (1)	254 Love Jonathan	1:04.59 (8) 05.27	2:13.96 (8) 10.05	3:23.88 (8) 14.22	4:30.59 13.72
9	FRA (9)	230 Ethuin David	1:06.18 (9) 06.86	2:15.06 (9) 11.15	3:26.74 (9) 17.08	4:39.79 22.92

1-4+the best 5th ->F rest ->out

Temperatur: -water 20 °C -air 17 °C Wind: 0.0m/sec

Chief Official: John Leukemans (BEL) Course Umpires: Amper D. (ISR) Bland P. (GBR)
Starters: Mike Moir (CAN) Finish Line judge: Gunter Byhan (GER)



23 Complete Office Equipment





International
Canoe Federation

5th WORLD JUNIOR
CANOE
CHAMPIONSHIPS



29.7. - 1.8. 1993
RAČICE
CZECH REPUBLIC



Czech Canoe
Union

VÝSLEDKOVÁ LISTINA / RESULT LIST

Datum/date 01.8.93

K4W 500 m

Junioren

Závod
Race **121**

Mezijízda/Semifinal 1

Cas/Time 09:46

			250 m	Total
1	HUN (5)	311 Bankuti Judit 314 Kovacs Katalin 312 Barocsi Andrea 315 Luchterhand Larissza	49.54 (1)	1:41.36
2	ESP (4)	191 Aramburu Izaskum 193 Iglesias Andrea 195 Romero Antonia 192 Fernandez Cristina	50.31 (2) 00.77	1:42.74 01.38
3	CZE (2)	134 Hlucha Katerina 131 Borkovcova Sarka 133 Hekova Katerina 136 Pergnerova Milena	51.03 (4) 01.49	1:43.09 01.73
4	BLR (8)	51 Bet Elena 52 Maslova Natalia 54 Subotenko Olga 53 Pajgraj Nadezhda	50.53 (3) 00.99	1:43.62 02.26
5	GBR (6)	245 Hemmings Anna 242 Fowler Suzanne 243 Giles Rebecca 246 Ormerod Emily	52.01 (5) 02.47	1:44.17 02.81
6	ITA (3)	352 Pellegrini Ilenia 351 Pedrazzi Silvia 353 Ricciotti Anne Odette 354 Silvestri Sara	52.34 (6) 02.80	1:44.88 03.52
7	CAN (9)	102 Giles Kristina 103 Mckenzie Laura 105 Prince Karina 101 Furneaux Karen	53.06 (8) 03.52	1:45.22 03.86
8	USA (1)	732 Beyer Tara 734 White Olivia 731 Ashford Elizabeth 733 Goodrow Genevieve	53.33 (9) 03.79	1:45.29 03.93
9	KAZ (7)	772 Parfjonova Elena 773 Muravjova Natalja 774 Voseva Olga 775 Caileva Elena	52.56 (7) 03.02	1:46.10 04.74

1-4+the best 5th →F rest →out

Temperatur: -water 20 °C -air 18 °C Wind: 0.0m/sec

Chief Official: John Leukemans (BEL) Course Umpires: Janssens (BEL) Navasart (ROM)
Starters: Otto Tomiuc (ROM) Finish Line judge: Gunter Byhan (GER)





International
Canoe Federation

5th WORLD JUNIOR
CANOE
CHAMPIONSHIPS



29.7. - 1.8. 1993
RAČICE
CZECH REPUBLIC



VÝSLEDKOVÁ LISTINA / RESULT LIST

Datum/date 01.8.93

K4W 500 m

Junioren

Závod
Race **122**

Mezijízda/Semifinal 2

Cas/Time 09:53

			250 m	Total
1	GER (5)	262 Mucke Manuela 263 Muller Heike 264 Opgen-Rhein Nadine 265 Wagner Katrin	49.27 (1)	1:41.37
2	UKR (8)	702 Kovalenko Anna 703 Litchman Tatiana 705 Yurtchenko Ekaterina 704 Tchaytchouk Alevtina	49.98 (3) 00.71	1:42.72 01.35
3	ROM(4)	553 Ionita Racula 552 Cristoa Mirola 556 Radu Blena 555 Pirvu Carmen	50.42 (4) 01.15	1:42.87 01.50
4	POL (7)	505 Slota Karolina 504 Pastuszka Aneta 503 Opara Monika 501 Gregorowicz Kinga	49.82 (2) 00.55	1:43.04 01.67
5	RUS (2)	595 Tishyenko Tatyana 591 Anikeyeva Yuliya 593 Minayeva Marina 592 Kononova Yuliya	51.36 (6) 02.09	1:43.47 02.10
6	SVK (6)	643 Kapisovska Svetlana 642 Hochschornerov Eva 641 Birvonova Miriam 645 Petranova Jana	51.14 (5) 01.87	1:44.05 02.68
7	SWE (3)	674 Karlsson Therese 671 Augustsson Lisen 672 Hamrin Jenny 675 Linder Ulrica	52.84 (7) 03.57	1:44.66 03.29
8	FRA (1)	225 Koenders Nathalie 222 Bonnefoy Cecile 221 Agnes Isabelle 224 Gaultier Anne Sophie	53.28 (9) 04.01	1:46.28 04.91
9	NOR (9)	483 Halano May Lise 484 Knuosen Christine 482 Fjeloheim Marianne 481 Berntsen Anne Grete	53.06 (8) 03.79	1:47.37 06.00

1-4+the best 5th ->F rest ->out

Temperatur: -water 20 °C -air 18 °C Wind: 0.6m/sec 160°

Chief Official: John Leukemans (BEL) Course Umpires: Horvath (HUN) Chielewska (POL)
Starters: Otto Tomiuc (ROM) Finish Line judge: Gunter Byhan (GER)



COMPUTER SYSTEMS





International
Canoe Federation

5th WORLD JUNIOR
CANOE
CHAMPIONSHIPS



29.7. - 1.8. 1993
RAČICE
CZECH REPUBLIC



Czech Canoe
Union

VÝSLEDKOVÁ LISTINA / RESULT LIST

Datum/date 01.8.93

K2M 1000 m

Junioren

Závod
Race

123

Mezijízda/Semifinal

1

Cas/Time 10:01

			250 m	500 m	750 m	Total
1	BUL (5)	85 Karadjov Petar 86 Merkov Petar	48.89 (4) 00.94	1:41.23 (1)	2:35.06 (2) 00.55	3:29.13
2	ESP (8)	201 Gonzales Jovino 204 Merchan Emilio	48.34 (2) 00.39	1:42.17 (3) 00.94	2:36.16 (4) 01.65	3:29.24 00.11
3	HUN (4)	333 Storcz Botond 330 Neuwirth Zsolt	47.95 (1)	1:41.84 (2) 00.61	2:34.51 (1)	3:29.33 00.20
4	ROM (6)	571 Sirbu Marian 562 Condrache Mihail	49.27 (5) 01.32	1:43.65 (6) 02.42	2:35.77 (3) 01.26	3:29.92 00.79
5	SWE (2)	678 Berglund Mats 680 Haglund Hans	49.66 (6) 01.71	1:44.31 (8) 03.08	2:39.34 (8) 04.83	3:30.38 01.25
6	POL (3)	507 Aleksandrowicz W. 511 Markiewicz Jaroslaw	49.88 (7) 01.93	1:43.26 (5) 02.03	2:37.31 (6) 02.80	3:30.62 01.49
7	BEL (1)	48 Vandenbruwaene Leslie 43 Maesen Bob	50.48 (8) 02.53	1:43.98 (7) 02.75	2:36.54 (5) 02.03	3:31.64 02.51
8	NOR (7)	486 Fjeloheim Nils Olav 489 Sigurosen Stian	48.56 (3) 00.61	1:42.88 (4) 01.65	2:38.02 (7) 03.51	3:32.11 02.98
9	CZE (9)	153 Sarka Jan 141 Hejda Premysl	51.58 (9) 03.63	1:44.53 (9) 03.30	2:40.61 (9) 06.10	3:37.86 08.73

1-4+the best 5th →F rest →out

Temperatur: -water 20 °C -air 18 °C Wind: 0.6m/sec 140°

Chief Official: John Leukemans (BEL)

Course Umpires: Amper D. (ISR) Bland P. (GBR)

Starters: Mike Moir (CAN)

Finish Line judge: Gunter Byhan (GER)





International
Canoe Federation

5th WORLD JUNIOR
CANOE
CHAMPIONSHIPS



29.7. - 1.8. 1993
RAČICE
CZECH REPUBLIC



Czech Canoe
Union

VÝSLEDKOVÁ LISTINA / RESULT LIST

Datum/date 01.8.93

K2M 1000 m

Junioren

Mezijízda/Semifinal 2

Cas/Time 10:14

Závod
Race **124**

			250 m	500 m	750 m	Total
1	LAT (4)	404 Balabolins Kaspars 406 Buncis Edgars	48.28 (2) 00.33	1:41.23 (2) 00.38	2:34.45 (3) 00.60	3:25.99
2	SVK (6)	651 Kuzel Rastislav 655 Simocko Radovan	49.93 (7) 01.98	1:43.04 (8) 02.19	2:34.67 (4) 00.82	3:26.18 00.19
3	GER (3)	272 Lehnert Sven 277 Schmiech Daniel	48.67 (3) 00.72	1:41.51 (3) 00.66	2:33.85 (1)	3:26.49 00.50
4	BLR (5)	56 Borisik Piotr 63 Povalanskij Valerij	47.95 (1)	1:40.85 (1)	2:34.12 (2) 00.27	3:26.81 00.82
5	FRA (2)	237 Robert Yann 235 Rebours Loic	49.55 (6) 01.60	1:41.78 (4) 00.93	2:34.89 (5) 01.04	3:27.71 01.72
6	LTU (1)	424 Gerulskis Edmundas 422 Balciunas Egidijus	50.70 (9) 02.75	1:42.77 (7) 01.92	2:36.32 (6) 02.47	3:30.13 04.14
7	ARG (7)	7 Suaya Pablo 3 Basualto Ariel	49.00 (4) 01.05	1:42.38 (6) 01.53	2:36.93 (7) 03.08	3:31.66 05.67
8	RUS (8)	599 Bazarov Alexandr 596 Sobolev	49.22 (5) 01.27	1:42.11 (5) 01.26	2:37.09 (8) 03.24	3:32.22 06.23
9	ITA (9)	360 Frattini Luca 355 Ciacchella Ottavio	50.43 (8) 02.48	1:43.48 (9) 02.63	2:38.13 (9) 04.28	3:32.36 06.37

1-4+the best 5th ->F rest ->out

Temperatur: -water 20 °C -air 19 °C Wind: 0.0m/sec

Chief Official: John Leukemans (BEL) Course Umpires: Janssens (BEL) Navasart (ROM)
Starters: Mike Moir (CAN) Finish Line judge: Gunter Byhan (GER)



COMPUTER SYSTEMS



Complete Office Equipment





International
Canoe Federation

5th WORLD JUNIOR
CANOE
CHAMPIONSHIPS



29.7. - 1.8. 1993
RAČICE
CZECH REPUBLIC



VÝSLEDKOVÁ LISTINA / RESULT LIST

Datum/date 1.8.1993

Závod
Race **125**

NO RACE



COMPUTER SYSTEMS





International
Canoe Federation

5th WORLD JUNIOR
CANOE
CHAMPIONSHIPS



29.7. - 1.8. 1993
RAČICE
CZECH REPUBLIC



Czech Canoe
Union

VÝSLEDKOVÁ LISTINA / RESULT LIST

Datum/date 01.8.93

C2M 1000 m Junioren

Mezijízda/Semifinal 1

Cas/Time 10:33

Závod
Race **126**

			250 m	500 m	750 m	Total
1	HUN (5)	324 Gyore Attila 322 Csikos Gergely	54.26 (2) 00.44	1:53.91 (2) 00.55	2:53.89 (1)	3:52.73
2	GER (7)	270 Hesse Jan 281 Zeisner Daniel	55.14 (4) 01.32	1:54.90 (4) 01.54	2:54.71 (3) 00.82	3:53.77 01.04
3	BUL (4)	88 Nikolov Rumén 82 Angelov Atanas	53.82 (1)	1:53.36 (1)	2:54.44 (2) 00.55	3:53.80 01.07
4	UKR (3)	714 Pavlov Vyatcheslav 709 Korenyuk Valentin	54.54 (3) 00.72	1:54.46 (3) 01.10	2:55.10 (4) 01.21	3:54.31 01.58
5	CZE (6)	151 Pojezny Petr 148 Machac Jan	57.39 (7) 03.57	1:57.48 (6) 04.12	2:55.81 (5) 01.92	3:55.78 03.05
6	RUS (2)	598 Artemida Alexandr 604 Kapitonov Alexej	57.12 (6) 03.30	1:58.58 (7) 05.22	2:59.05 (7) 05.16	4:00.07 07.34
7	BLR (8)	60 Kirilenko Victor 68 Zujev Vitalij	55.31 (5) 01.49	1:55.72 (5) 02.36	2:57.02 (6) 03.13	4:01.62 08.89
8	MEX (9)	443 Castaneda Jose Luis 442 Castaneda Benjamin	59.15 (8) 05.33	2:02.42 (8) 09.06	3:07.68 (8) 13.79	4:12.24 19.51
9	USA (1)	737 Johnson Nate 735 Batlik Vaclav	1:00.47 (9) 06.65	2:06.43 (9) 13.07	3:11.96 (9) 18.07	4:16.11 23.38

1-4+the best 5th ->F rest ->out

Temperatur: -water 20 °C -air 19 °C Wind: 0.7m/sec 130°

Chief Official: John Leukemans (BEL) Course Umpires: Amper D. (ISR) Bland P. (GBR)
Starters: Mike Moir (CAN) Finish Line judge: Gunter Byhan (GER)



Complete Office Equipment





International
Canoe Federation

5th WORLD JUNIOR
CANOE
CHAMPIONSHIPS



29.7. - 1.8. 1993
RAČICE
CZECH REPUBLIC



Czech Canoe
Union

VÝSLEDKOVÁ LISTINA / RESULT LIST

Datum/date 01.8.93

C2M 1000 m Junioren

Mezijízda/Semifinal 2

Cas/Time 10:41

Závod
Race **127**

			250 m	500 m	750 m	Total
1	POL (6)	514 Pietrzak Artur 516 Rudny Arkadiusz	55.53 (2) 00.17	1:54.90 (1)	2:54.72 (1)	3:54.91
2	CAN (5)	113 Phelan Richard 107 Buday Tamas	56.79 (4) 01.43	1:56.61 (3) 01.71	2:56.20 (2) 01.48	3:57.76 02.85
3	ESP (4)	203 Mascato David 206 Perez Gustavo	55.36 (1)	1:55.40 (2) 00.50	2:57.19 (3) 02.47	3:59.02 04.11
4	ITA (7)	367 Ventriglia Alessandro 364 Nardi Claudio	59.21 (8) 03.85	1:59.35 (5) 04.45	3:00.21 (5) 05.49	4:00.03 05.12
5	LAT (8)	410 Lagzdins Valentins 409 Kovalovs Sergejs	56.46 (3) 01.10	1:58.42 (4) 03.52	2:59.83 (4) 05.11	4:01.79 06.88
6	FRA (3)	233 Moreaux Denis 234 Normand Samuel	57.89 (5) 02.53	2:00.29 (6) 05.39	3:01.53 (6) 06.81	4:03.08 08.17
7	GBR (1)	248 Crowther Stuart 253 Lane Malcolm	58.44 (6) 03.08	2:02.21 (7) 07.31	3:04.66 (7) 09.94	4:05.79 10.88
8	LTU (2)	427 Medvedev Konstantin 430 Polomosnov Andrej	59.04 (7) 03.68	2:02.65 (8) 07.75	3:05.87 (8) 11.15	4:07.69 12.78
9	JPN (9)	377 Hiroyuki Sato 380 Kiyoshige Saito	1:00.25 (9) 04.89	2:03.97 (9) 09.07	3:09.99 (9) 15.27	4:15.86 20.95

1-4+the best 5th ->F rest ->out

Temperatur: -water 20 °C -air 19 °C Wind: 0.8m/sec 90°

Chief Official: John Leukemans (BEL)

Course Umpires: Janssens (BEL) Navasart (ROM)

Starters: Mike Moir (CAN)

Finish Line judge: Gunter Byhan (GER)

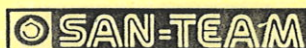



International
Canoe Federation

5th WORLD JUNIOR
CANOE
CHAMPIONSHIPS



29.7. - 1.8. 1993
RAČICE
CZECH REPUBLIC



VÝSLEDKOVÁ LISTINA / RESULT LIST

Datum/date 01.8.93

K4M 1000 m Junioren

Mezijízda/Semifinal 1

Cas/Time 10:51

Závod
Race **128**

			250 m	500 m	750 m	Total
1	GER (4)	279 Ulm Stefan 273 Mai Andre 272 Lehnert Sven 274 Patzack Jens	43.50 (1)	1:31.34 (1)	2:20.94 (1)	3:07.88
2	ROM(3)	562 Condrache Mihail 564 Enache Mihail 567 Hanches Ioan 571 Sirbu Marian	43.99 (2) 00.49	1:32.33 (2) 00.99	2:21.32 (2) 00.38	3:10.07 02.19
3	CZE (2)	159 Vanicek Vit 140 Dvorak Martin 157 Termer Vlastimil 158 Tonder Tomas	47.29 (9) 03.79	1:34.09 (5) 02.75	2:23.25 (5) 02.31	3:10.97 03.09
4	ESP (6)	202 Leal Carlos 198 Cuinas Antonio 200 Garcia Carlos 197 Busto Manuel	44.93 (3) 01.43	1:32.71 (3) 01.37	2:21.82 (3) 00.88	3:11.81 03.93
5	UKR (1)	715 Sivko Alexandr 720 Zhebrowski Serguei 706 Berzin Serguei 713 Navitnyi Oleg	46.19 (7) 02.69	1:35.46 (8) 04.12	2:24.62 (8) 03.68	3:12.33 04.45
6	LAT (8)	404 Balabolins Kaspars 406 Buncis Edgars 412 Zalupe Kristaps 407 Greizis Ugis	45.75 (5) 02.25	1:34.44 (6) 03.10	2:23.74 (6) 02.80	3:12.79 04.91
7	FRA (7)	238 Vossion Damien 229 Bocage Etienne 236 Richard Alban 231 Huguet Cyril	45.90 (6) 02.40	1:34.58 (7) 03.24	2:24.34 (7) 03.40	3:13.82 05.94
8	ITA (5)	357 Blasi Andrea 366 Favalli Simone 368 Nardelli Ciro 363 Mate Davide	45.31 (4) 01.81	1:33.59 (4) 02.25	2:22.04 (4) 01.10	3:14.35 06.47
9	RSA (9)	581 Caldwell Stuart 585 Stenhouse Matthew 582 Du Toit Sakkie 583 Leonard Danie	46.52 (8) 03.02	1:36.01 (9) 04.67	2:26.60 (9) 05.66	3:15.36 07.48

1-4+the best 5th ->F rest ->out

Temperatur: -water 20 °C -air 19 °C Wind: 0.2m/sec 120°

Chief Official: John Leukemans (BEL) Course Umpires: Horvath (HUN) Chielewska (POL)
Starters: Mike Moir (CAN) Finish Line judge: Gunter Byhan (GER)



COMPUTER SYSTEMS



Complete Office Equipment





International
Canoe Federation

5th WORLD JUNIOR
CANOE
CHAMPIONSHIPS



29.7. - 1.8. 1993
RAČICE
CZECH REPUBLIC



Czech Canoe
Union

VÝSLEDKOVÁ LISTINA / RESULT LIST

Datum/date 01.8.93

K4M 1000 m		Junioren		Cas/Time		11:05		Závod Race	129
Mezijízda/Semifinal	2			250 m	500 m	750 m	Total		
1	HUN (5)	320	Bauer Marton	45.10 (3)	1:34.69 (3)	2:24.84 (5)	3:10.58		
		330	Neuwirth Zsolt	01.10	02.36	02.58			
		317	Acs Tamas						
		327	Kovacs Akos						
2	SVK (7)	649	Kasuba Lucian	46.80 (7)	1:35.02 (4)	2:23.69 (3)	3:11.17		
		647	Brodsky Ladislav	02.80	02.69	01.43	00.59		
		650	Kiss Roman						
		656	Straka Peter						
3	BLR (9)	57	Degtiariov Vladislav	44.00 (1)	1:32.33 (1)	2:22.26 (1)	3:11.54		
		63	Povalanskij Valerij				00.96		
		56	Borisik Piotr						
		64	Rubanov Gennadij						
4	POL (6)	518	Wolff Pawel	44.44 (2)	1:33.21 (2)	2:23.08 (2)	3:12.49		
		515	Porowski Wlodzimierz	00.44	00.88	00.82	01.91		
		520	Zurek Ireneusz						
		509	Lakomy Pawel						
5	POR (1)	537	Silva Ludgero	46.03 (5)	1:37.55 (9)	2:27.15 (9)	3:13.07		
		538	Sousa Jose	02.03	05.22	04.89	02.49		
		534	Fazenda Diogo						
		533	Almeida Carlos						
6	DEN (8)	172	Eilert Michael	47.51 (8)	1:35.46 (5)	2:24.62 (4)	3:13.21		
		177	Rasmussen Brian	03.51	03.13	02.36	02.63		
		179	Svenningen Claus						
		174	Heering Nicolai						
7	RUS (4)	600	Chertov Oleg	46.30 (6)	1:35.96 (6)	2:25.55 (6)	3:13.43		
		612	Tissin Andrei	02.30	03.63	03.29	02.85		
		610	Mironyuk Andrej						
		597	Andin Nikolaj						
8	SWE (2)	683	Oscarsson Markus	45.81 (4)	1:36.56 (7)	2:26.76 (8)	3:16.24		
		678	Berglund Mats	01.81	04.23	04.50	05.66		
		679	Edlund Daniel						
		677	Adlers Daniel						
9	AUS (3)	14	Beresford-Peir Digby	48.12 (9)	1:37.00 (8)	2:25.83 (7)	3:16.47		
		13	Baggaley Nathan	04.12	04.67	03.57	05.89		
		17	Clayton James						
		18	Croker Glen						

1-4+the best 5th ->F rest ->out

Temperatur: -water 20 °C -air 20 °C Wind: 0.0m/sec

Chief Official: John Leukemans (BEL) Course Umpires: Amper D. (ISR) Bland P. (GBR)
Starters: Mike Moir (CAN) Finish Line judge: Gunter Byhan (GER)



COMPUTER SYSTEMS



O.E.

Complete Office Equipment





International
Canoe Federation

5th WORLD JUNIOR
CANOE
CHAMPIONSHIPS



29.7. - 1.8. 1993
RACICE
CZECH REPUBLIC



VÝSLEDKOVÁ LISTINA / RESULT LIST

Datum/date 01.8.93

C4M 1000 m Junioren Závod Race **130**
Mezijízda/Semifinal 1 Cas/Time 11:11

			250 m	500 m	750 m	Total
1	UKR (4)	717 Tchounyak Alexandr 714 Pavlov Vyatcheslav 710 Kovaltchouk Andrei 709 Korenyuk Valentin	50.75 (1)	1:44.91 (2) 00.38	2:39.78 (2) 00.16	3:33.83
2	BUL (5)	83 Atanasov Dimitar 84 Atanasov Stanimir 89 Petrov Genaedi 90 Spasov Trendafil	50.92 (2) 00.17	1:44.53 (1)	2:39.62 (1)	3:34.50 00.67
3	RUS (2)	607 Lantsayev Vasilij 601 Elizarov Maxim 606 Kruzshilin Oleg 602 Gherasiov Victor	52.29 (4) 01.54	1:46.01 (3) 01.48	2:41.54 (3) 01.92	3:34.68 00.85
4	GRE (3)	305 Zachos Lukas 303 Terzithis Teofanis 294 Arapis Athanasios 297 Kiriazis Dimitrious	52.13 (3) 01.38	1:47.82 (4) 03.29	2:50.16 (4) 10.54	3:53.19 19.36
5	JPN (6)	375 Eiji Uejyo 386 Yoshimi Hosotani 377 Hiroyuki Sato 380 Kiyoshige Saito	57.95 (5) 07.20	1:59.79 (5) 15.26	2:59.87 (5) 20.25	4:03.28 29.45

1-2+the best 3rd ->F rest ->out

Temperatur: -water 20 °C -air 20 °C Wind: 0.7m/sec 30°

Chief Official: John Leukemans (BEL) Course Umpires: Janssens (BEL) Navasart (ROM)
Starters: Mike Moir (CAN) Finish Line judge: Gunter Byhan (GER)



VÝSLEDKOVÁ LISTINA / RESULT LIST

Datum/date 01.8.93

C4M 1000 m Junioren

Mezijízda/Semifinal 2

Cas/Time 11:20

Závod
Race **131**

			250 m	500 m	750 m	Total
1	FRA (5)	230 Ethuin David 232 Lavigne Yannick 227 Assa Martin 228 Barbey Laurent	51.69 (1)	1:47.27 (1)	2:44.61 (1)	3:41.48
2	CZE (3)	149 Marisko Jan 137 Brecka Jan 142 Juttner Tomas 148 Machac Jan	53.77 (2) 02.08	1:50.79 (2) 03.52	2:48.73 (2) 04.12	3:46.27 04.79
3	LTU (2)	429 Paulauskas Dainius 427 Medvedev Konstantin 430 Polomosnov Andrej 426 Jonkus Mindaugas	54.98 (3) 03.29	1:53.53 (3) 06.26	2:51.70 (3) 07.09	3:46.90 05.42
	BLR (6)	68 Zujev Vitalij 60 Kirilenko Victor 66 Zhookovskij Dmitrij 62 Markosian Mikhail				Don't ended

1-2+the best 3rd →F

Temperatur: -water 20 °C -air 20 °C Wind: 0.7m/sec 90°

Chief Official: John Leukemans (BEL)

Course Umpires: Horvath (HUN) Chielewska (POL)

Starters: Mike Moir (CAN)

Finish Line judge: Gunter Byhan (GER)



International
Canoe Federation

5th WORLD JUNIOR
CANOE
CHAMPIONSHIPS



29.7. - 1.8. 1993
RAČICE
CZECH REPUBLIC



VÝSLEDKOVÁ LISTINA / RESULT LIST

Datum/date 01.8.93

K1M 1000 m Junioren

Závod
Race **132**

Finále/Final

Cas/Time 15:36

			250 m	500 m	750 m	Total
1	GER (5) 279	Ulm Stefan	51.79 (3) 00.88	1:47.98 (1)	2:45.16 (1)	3:40.66
2	UKR (2) 711	Kutcherenko Serguei	52.56 (4) 01.65	1:49.41 (4) 01.43	2:46.91 (3) 01.75	3:42.67 02.01
3	HUN (4) 320	Bauer Marton	51.41 (2) 00.50	1:48.86 (3) 00.88	2:47.68 (4) 02.52	3:42.73 02.07
4	AUS (6) 20	Evans Peter	50.91 (1)	1:48.42 (2) 00.44	2:46.75 (2) 01.59	3:44.81 04.15
5	SVK (8) 651	Kuzel Rastislav	54.15 (7) 03.24	1:51.82 (6) 03.84	2:48.45 (5) 03.29	3:45.08 04.42
6	DEN (3) 174	Heering Nicolai	54.70 (8) 03.79	1:53.42 (9) 05.44	2:51.14 (8) 05.98	3:46.60 05.94
7	ESP (7) 198	Cuinas Antonio	52.72 (5) 01.81	1:50.67 (5) 02.69	2:49.00 (6) 03.84	3:46.65 05.99
8	ITA (9) 361	Majocchi Jacopo	53.66 (6) 02.75	1:52.37 (7) 04.39	2:50.92 (7) 05.76	3:47.41 06.75
9	FRA (1) 231	Huguet Cyril	55.20 (9) 04.29	1:52.98 (8) 05.00	2:51.75 (9) 06.59	3:47.85 07.19

Temperatur: -water 22 °C -air 27 °C Wind: 0.0m/sec

Chief Official: John Leukemans (BEL)
Starters: Mike Moir (CAN)

Course Umpires: Amper D. (ISR) Bland P. (GBR)
Finish Line judge: Gunter Byhan (GER)



Complete Office Equipment





International
Canoe Federation

5th WORLD JUNIOR
CANOE
CHAMPIONSHIPS



29.7. - 1.8. 1993
RACICE
CZECH REPUBLIC



VÝSLEDKOVÁ LISTINA / RESULT LIST

Datum/date 01.8.93

C1M 1000 m Junioren

Finále/Final

Cas/Time 16:03

Závod
Race **133**

			250 m	500 m	750 m	Total
1	ESP (4)	203 Mascato David	57.18 (1)	1:59.30 (1)	3:03.72 (1)	4:10.19
2	GER (7)	266 Bebber Ricardo	1:00.03 (3) 02.85	2:03.75 (4) 04.45	3:07.29 (2) 03.57	4:12.39 02.20
3	CAN (1)	107 Buday Tamas	1:00.58 (5) 03.40	2:04.13 (5) 04.83	3:08.12 (4) 04.40	4:15.30 05.11
4	ROM(3)	568 Huidu Florian	59.65 (2) 02.47	2:01.88 (2) 02.58	3:07.79 (3) 04.07	4:15.32 05.13
5	CRO (6)	123 Funtak Drazen	1:00.25 (4) 03.07	2:03.31 (3) 04.01	3:08.34 (5) 04.62	4:15.61 05.42
6	DEN (9)	178 Scales Carsten	1:02.34 (8) 05.16	2:07.04 (8) 07.74	3:12.13 (7) 08.41	4:16.54 06.35
7	POL (2)	508 Kondracki Edward	1:02.01 (7) 04.83	2:06.66 (7) 07.36	3:11.80 (6) 08.08	4:16.59 06.40
8	LAT (8)	408 Klava Ainars	1:00.91 (6) 03.73	2:05.72 (6) 06.42	3:12.35 (8) 08.63	4:21.22 11.03
	HUN(5)	319 Balgovits Gabor				Diskvalifikation

Temperatur: -water 22 °C -air 27 °C Wind: 1.3m/sec 30°

Chief Official: John Leukemans (BEL) Course Umpires: Janssens (BEL) Navasart (ROM)
Starters: Mike Moir (CAN) Finish Line judge: Gunter Byhan (GER)



COMPUTER SYSTEMS



Complete Office Equipment





International
Canoe Federation

5th WORLD JUNIOR
CANOE
CHAMPIONSHIPS



29.7. - 1.8. 1993
RACICE
CZECH REPUBLIC



Czech Canoe
Union

VÝSLEDKOVÁ LISTINA / RESULT LIST

Datum/date 01.8.93

K4W 500 m

Junioren

Závod
Race

134

Finále/Final

Cas/Time 16:30

			250 m	Total
1	GER (4)	262 Mucke Manuela 263 Muller Heike 264 Opgen-Rhein Nadine 265 Wagner Katrin	48.34 (1)	1:39.14
2	HUN (5)	311 Bankuti Judit 314 Kovacs Katalin 312 Barocsi Andrea 315 Luchterhand Larissza	49.82 (5) 01.48	1:40.18 01.04
3	ESP (6)	191 Aramburu Izaskum 193 Iglesias Andrea 195 Romero Antonia 192 Fernandez Cristina	49.44 (3) 01.10	1:40.72 01.58
4	POL (1)	505 Slota Karolina 504 Pastuszka Aneta 503 Opara Monika 501 Gregorowicz Kinga	49.93 (6) 01.59	1:41.46 02.32
5	ROM (2)	553 Ionita Racula 552 Cristoa Mirola 556 Radu Blena 555 Pirvu Carmen	50.92 (7) 02.58	1:41.57 02.43
6	CZE (7)	134 Hlucha Katerina 131 Borkovcova Sarka 133 Hekova Katerina 136 Pergnerova Milena	49.66 (4) 01.32	1:42.18 03.04
7	BLR (8)	51 Bet Elena 52 Maslova Natalia 54 Subotenko Olga 53 Pajgraj Nadezhda	49.05 (2) 00.71	1:43.10 03.96
8	UKR (3)	702 Kovalenko Anna 703 Litchman Tatiana 705 Yurtchenko Ekaterina 704 Tchaytchouk Alevtina	51.25 (8) 02.91	1:43.59 04.45
9	RUS (9)	595 Tishyenko Tatyana 591 Anikeyeva Yuliya 593 Minayeva Marina 592 Kononova Yuliya	51.80 (9) 03.46	1:44.48 05.34

Temperatur: -water 22 °C -air 27 °C Wind: 1.4m/sec 160°

Chief Official: John Leukemans (BEL)

Course Umpires: Horvath (HUN) Chielewska (POL)

Starters: Otto Tomiuc (ROM)

Finish Line judge: Gunter Byhan (GER)





International
Canoe Federation

5th WORLD JUNIOR
CANOE
CHAMPIONSHIPS



29.7. - 1.8. 1993
RAČICE
CZECH REPUBLIC



VÝSLEDKOVÁ LISTINA / RESULT LIST

Datum/date 01.8.93

K2M 1000 m Junioren

Finále/Final

Cas/Time 17:01

Závod
Race **135**

			250 m	500 m	750 m	Total
1	SVK (3)	651 Kuzel Rastislav 655 Simocko Radovan	50.09 (8) 03.57	1:41.72 (5) 02.91	2:33.35 (4) 01.64	3:22.11
2	HUN (7)	333 Storcz Botond 330 Neuwirth Zsolt	46.52 (1)	1:38.81 (1)	2:31.71 (1)	3:23.20 01.09
3	GER (2)	272 Lehnert Sven 277 Schmiech Daniel	48.72 (6) 02.20	1:39.69 (3) 00.88	2:31.98 (2) 00.27	3:23.29 01.18
4	LAT (4)	404 Balabolins Kaspars 406 Buncis Edgars	49.10 (7) 02.58	1:42.11 (6) 03.30	2:35.82 (8) 04.11	3:25.85 03.74
5	BUL (5)	85 Karadjov Petar 86 Merkov Petar	47.57 (3) 01.05	1:40.08 (4) 01.27	2:33.19 (3) 01.48	3:26.84 04.73
6	ROM(8)	571 Sirbu Marian 562 Condrache Mihail	50.92 (9) 04.40	1:44.25 (9) 05.44	2:37.69 (9) 05.98	3:27.39 05.28
7	FRA (9)	237 Robert Yann 235 Rebours Loic	48.23 (4) 01.71	1:42.60 (8) 03.79	2:35.28 (7) 03.57	3:27.54 05.43
8	BLR (1)	56 Borisik Piotr 63 Povalanskij Valerij	46.80 (2) 00.28	1:39.36 (2) 00.55	2:33.52 (5) 01.81	3:28.92 06.81
9	ESP (6)	201 Gonzales Jovino 204 Merchan Emilio	48.45 (5) 01.93	1:42.38 (7) 03.57	2:35.00 (6) 03.29	3:28.93 06.82

Temperatur: -water 22 °C -air 26 °C Wind: 1.5m/sec 170°

Chief Official: John Leukemans (BEL)
Starters: Mike Moir (CAN)

Course Umpires: Amper D. (ISR) Bland P. (GBR)
Finish Line judge: Gunter Byhan (GER)



Complete Office Equipment



VÝSLEDKOVÁ LISTINA / RESULT LIST

Datum/date 01.8.93

C2M 1000 m Junioren

Finále/Final

Cas/Time 17:30

Závod
Race **136**

			250 m	500 m	750 m	Total
1	HUN (5)	324 Gyore Attila 322 Csikos Gergely	54.87 (3) 00.39	1:54.90 (5) 02.25	2:51.53 (1)	3:49.28
2	ESP (2)	203 Mascato David 206 Perez Gustavo	55.58 (6) 01.10	1:53.86 (3) 01.21	2:52.96 (3) 01.43	3:50.70 01.42
3	POL (4)	514 Pietrzak Artur 516 Rudny Arkadiusz	55.36 (5) 00.88	1:52.65 (1)	2:52.24 (2) 00.71	3:50.73 01.45
4	CAN (3)	113 Phelan Richard 107 Buday Tamas	55.91 (7) 01.43	1:53.14 (2) 00.49	2:53.95 (4) 02.42	3:53.41 04.13
5	GER (6)	270 Hesse Jan 281 Zeisner Daniel	55.09 (4) 00.61	1:55.29 (6) 02.64	2:54.11 (5) 02.58	3:53.92 04.64
6	UKR (8)	714 Pavlov Vyatcheslav 709 Korenyuk Valentin	54.48 (1)	1:54.41 (4) 01.76	2:55.98 (7) 04.45	3:54.92 05.64
7	ITA (1)	367 Ventriglia Alessandro 364 Nardi Claudio	57.94 (9) 03.46	1:59.35 (9) 06.70	2:57.85 (9) 06.32	3:55.69 06.41
8	CZE (9)	151 Pojezny Petr 148 Machac Jan	56.57 (8) 02.09	1:58.20 (8) 05.55	2:56.80 (8) 05.27	3:56.40 07.12
9	BUL (7)	88 Nikolov Rumén 82 Angelov Atanas	54.65 (2) 00.17	1:57.48 (7) 04.83	2:55.70 (6) 04.17	4:05.88 16.60

Temperatur: -water 22 °C -air 25 °C Wind: 1.6m/sec 180°

Chief Official: John Leukemans (BEL) Course Umpires: Janssens (BEL) Navasart (ROM)
Starters: Mike Moir (CAN) Finish Line judge: Tarcsafalvi J. (HUN)



International
Canoe Federation

5th WORLD JUNIOR
CANOE
CHAMPIONSHIPS



29.7. - 1.8. 1993
RAČICE
CZECH REPUBLIC



Czech Canoe
Union

VÝSLEDKOVÁ LISTINA / RESULT LIST

Datum/date 01.8.93

K4M 1000 m Juniores

Finále/Final

Cas/Time 18:02

Závod
Race **137**

		250 m	500 m	750 m	Total
1	HUN (4) 320 Bauer Marton 330 Neuwirth Zsolt 317 Acs Tamas 327 Kovacs Akos	44.32 (2) 00.66	1:32.87 (3) 02.30	2:20.44 (2) 01.48	3:06.98
2	GER (5) 279 Ulm Stefan 273 Mai Andre 272 Lehnert Sven 274 Patzack Jens	43.66 (1)	1:30.57 (1)	2:18.96 (1)	3:07.06 00.08
3	ROM(6) 562 Condrache Mihail 564 Enache Mihail 567 Hanches Ioan 571 Sirbu Marian	44.49 (3) 00.83	1:32.16 (2) 01.59	2:21.04 (3) 02.08	3:09.07 02.09
4	SVK (3) 649 Kasuba Lucian 647 Brodsky Ladislav 650 Kiss Roman 656 Straka Peter	47.29 (7) 03.63	1:34.96 (5) 04.39	2:22.88 (5) 03.92	3:09.28 02.30
5	CZE (7) 159 Vanicek Vit 140 Dvorak Martin 157 Termer Vlastimil 158 Tonder Tomas	48.60 (8) 04.94	1:34.58 (4) 04.01	2:22.42 (4) 03.46	3:10.74 03.76
6	POL (1) 518 Wolff Pawel 515 Porowski Wlodzimierz 520 Zurek Ireneusz 509 Lakomy Pawel	47.12 (6) 03.46	1:35.73 (7) 05.16	2:23.63 (6) 04.67	3:12.70 05.72
7	POR (2) 537 Silva Ludgero 538 Sousa Jose 534 Fazenda Diogo 533 Almeida Carlos	49.10 (9) 05.44	1:37.32 (9) 06.75	2:25.33 (8) 06.37	3:14.19 07.21
8	ESP (8) 202 Leal Carlos 198 Cuinas Antonio 200 Garcia Carlos 197 Busto Manuel	45.80 (4) 02.14	1:35.35 (6) 04.78	2:25.11 (7) 06.15	3:15.96 08.98
9	UKR (9) 715 Sivko Alexandr 720 Zhembrovski Serguei 706 Berzin Serguei 713 Navitnyi Oleg	46.02 (5) 02.36	1:36.72 (8) 06.15	2:27.03 (9) 08.07	3:17.30 10.32

Temperatur: -water 22 °C -air 25 °C Wind: 0.0m/sec

Chief Official: John Leukemans (BEL)

Starters: Mike Moir (CAN)

Course Umpires: Horvath (HUN) Chielewska (POL)

Finish Line judge: Tarcsfalvi J.(HUN)



telekomunikace



COMPUTER SYSTEMS



Complete Office Equipment





International
Canoe Federation

5th WORLD JUNIOR
CANOE
CHAMPIONSHIPS



29.7. - 1.8. 1993
RAČICE
CZECH REPUBLIC



Czech Canoe
Union

VÝSLEDKOVÁ LISTINA / RESULT LIST

Datum/date 01.8.93

C4M 1000 m Junioren

Finále/Final

Cas/Time 18:30

Závod
Race **138**

			250 m	500 m	750 m	Total
1	GER (5)	267 Gille Christian 278 Tiedge Rene 280 Vesely Kay 266 Bebber Ricardo	49.10 (2) 00.38	1:43.26 (2) 02.53	2:36.43 (2) 01.65	3:27.66
2	ROM(4)	565 Glavan Marcel 568 Huidu Florian 566 Grigore Sami 570 Mardale Cristian	48.72 (1)	1:40.73 (1)	2:34.78 (1)	3:28.96 01.30
3	HUN(3)	319 Balgovits Gabor 335 Telek Gabor 331 Redenszki Antal 324 Gyore Attila	51.74 (7) 03.02	1:44.14 (3) 03.41	2:41.31 (7) 06.53	3:32.83 05.17
4	BUL (8)	83 Atanasov Dimitar 84 Atanasov Stanimir 89 Petrov Genaedi 90 Spasov Trendafil	51.13 (5) 02.41	1:44.69 (4) 03.96	2:38.40 (3) 03.62	3:33.39 05.73
5	UKR (7)	717 Tchounyak Alexandr 714 Pavlov Vyatcheslav 710 Kovaltchouk Andrei 709 Korenyuk Valentin	50.53 (3) 01.81	1:46.33 (7) 05.60	2:40.22 (5) 05.44	3:33.95 06.29
6	RUS (9)	607 Lantsayev Vasilij 601 Elizarov Maxim 606 Kruzshilin Oleg 602 Gherasiov Victor	50.69 (4) 01.97	1:45.40 (5) 04.67	2:40.66 (6) 05.88	3:34.31 06.65
7	CZE (1)	149 Marisko Jan 137 Brecka Jan 142 Juttner Tomas 148 Machac Jan	51.41 (6) 02.69	1:47.38 (9) 06.65	2:42.03 (8) 07.25	3:35.84 08.18
8	FRA (2)	230 Ethuin David 232 Lavigne Yannick 227 Assa Martin 228 Barbey Laurent	52.23 (8) 03.51	1:47.05 (8) 06.32	2:42.63 (9) 07.85	3:40.06 12.40
9	POL (6)	519 Zajaczkowski Slawomir 517 Watkowski Norbert 512 Midloch Pawel 513 Midloch Piotr	52.78 (9) 04.06	1:45.84 (6) 05.11	2:39.78 (4) 05.00	3:46.72 19.06

Temperatur: -water 22 °C -air 25 °C Wind: 0.0m/sec

Chief Official: John Leukemans (BEL)

Course Umpires: Amper D. (ISR) Bland P. (GBR)

Starters: Mike Moir (CAN)

Finish Line judge: Tarcsfalvi J.(HUN)



COMPUTER SYSTEMS



Complete Office Equipment



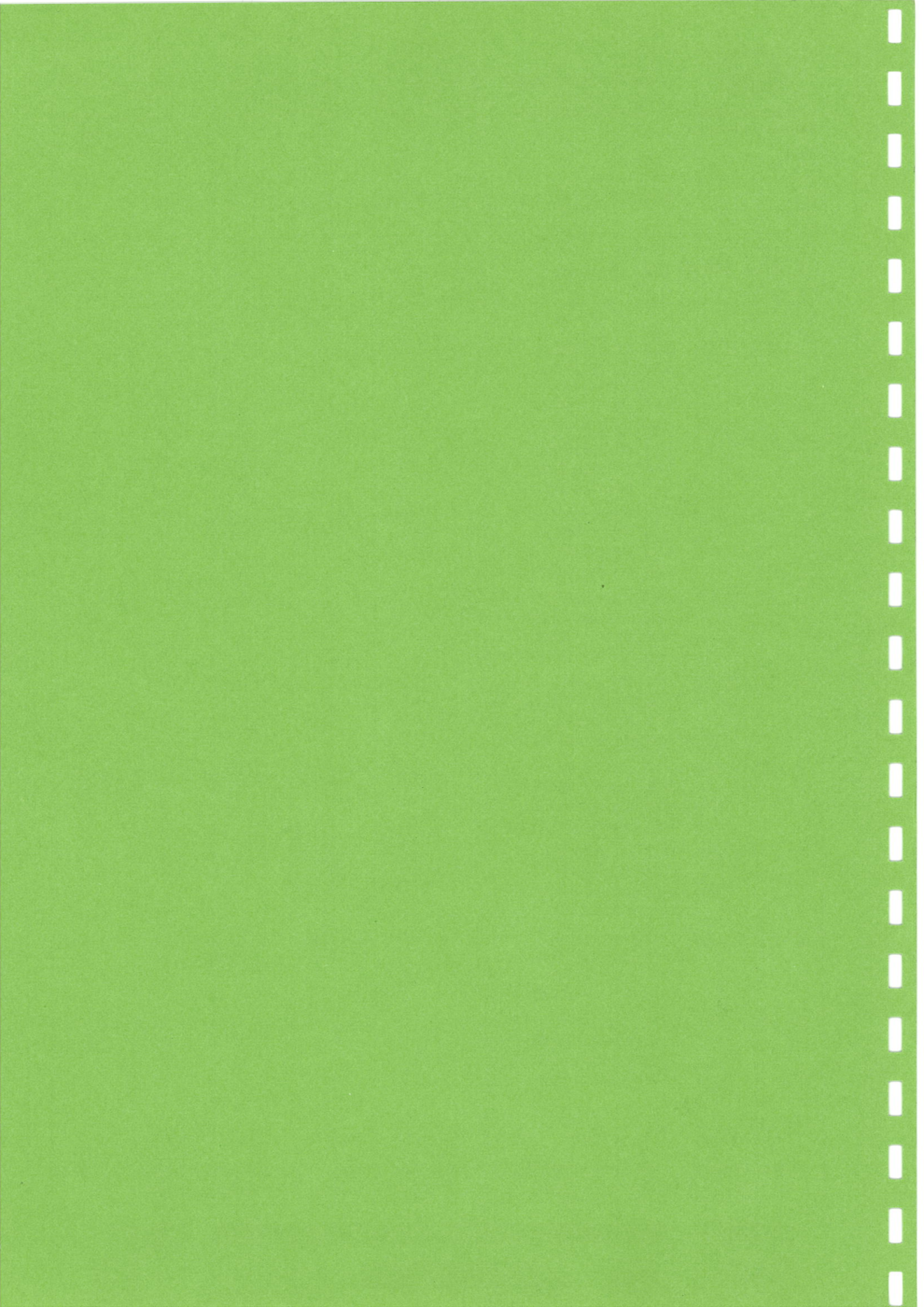

Klasifikace podle bodů / Most sufficient country

Rank	Code	Country	Kayak Men	Kayak Women	Canoe Men	Total
1	GER	Germany	49	30	42	121
2	HUN	Hungary	51	21	37	109
3	ESP	Spain	24	16	29	69
4	ROM	Romania	16	15	31	62
5	POL	Poland	9	18	18	45
6	SVK	Slovakia	34	8	0	42
7	BUL	Bulgaria	8	0	30	38
8	CZE	Czech Republic	8	16	11	35
9	UKR	Ukraine	9	3	19	31
10	BLR	Belarus	18	6	4	28
11	RUS	Russia	5	1	12	18
12	LAT	Latvia	13	0	3	16
13	CAN	Canada	0	0	15	15
14	CRO	Croatia	0	0	12	12
15	AUS	Australia	11	0	0	11
15	FRA	France	7	0	4	11
17	DEN	Denmark	4	0	4	8
18	ITA	Italy	2	0	3	5
19	BEL	Belgium	4	0	0	4
19	POR	Portugal	4	0	0	4
21	SWE	Sweden	0	3	0	3
22	GRE	Greece	0	0	1	1
22	ISR	Israel	0	1	0	1
	ARG	Argentina				
	AUT	Austria				
	BRA	Brazil				
	EST	Estonia				
	FIN	Finland				
	GBR	Great Britain				
	GEO	Georgia				
	JPN	Japan				
	KAZ	Kazachstan				
	KOR	Korea				
	LTU	Lithuania				
	MEX	Mexico				
	MLD	Moldava				
	NED	Niederland				
	NOR	Norway				
	RSA	South Africa				
	SLO	Slovenia				
	SUI	Swiss				
	TKM	Turkmenistan				
	USA	U.S.A.				

Klasifikace podle medailí / Statistics of medals

Rank	Code	Country	Gold	Silver	Bronz
1	GER	Germany	6	4	2
2	HUN	Hungary	3	6	2
3	BUL	Bulgaria	2		
4	ESP	Spain	1	1	4
5	ROM	Romania	1	1	2
6	BLR	Belarus	1		
6	SVK	Slovakia	1		
8	UKR	Ukraine		2	
9	CZE	Czech Republic		1	
10	POL	Poland			2
11	CAN	Canada			1
11	CRO	Croatia			1
11	LAT	Latvia			1
	ARG	Argentina			
	AUS	Australia			
	AUT	Austria			
	BEL	Belgium			
	BRA	Brazil			
	DEN	Denmark			
	EST	Estonia			
	FIN	Finland			
	FRA	France			
	GBR	Great Britain			
	GEO	Georgia			
	GRE	Greece			
	ISR	Israel			
	ITA	Italy			
	JPN	Japan			
	KAZ	Kazachstan			
	KOR	Korea			
	LTU	Lithuania			
	MEX	Mexico			
	MLD	Moldava			
	NED	Niederland			
	NOR	Norway			
	POR	Portugal			
	RSA	South Africa			
	RUS	Russia			
	SLO	Slovenia			
	SUI	Swiss			
	SWE	Sweden			
	TKM	Turkmenistan			
	USA	U.S.A.			